



**KHALNN**  
SUPERHARD TOOLS



SOLUTIONS FOR  
WIND POWER & CONSTRUCTION MACHINERY INDUSTRY







# Main Component

**Bearings**



**Gears**



**Drive Shafts**



**Main Shafts**



**Hubs**



**Planetary Carriers**

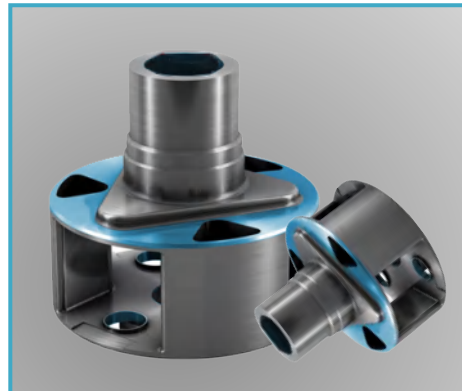

**Blades**



**Hydraulic Valves**



# Cutting Tool Applications

1、Turning

2、Milling

3、Drilling

4、Threading

5、Boring

6、Reaming





# Turning: Pre-Heat & Post-Heat Processing

## Pre-Heat Turning: Carbide Inserts

Mainly used for pre-heat machining of gear end faces and inner holes, outer diameters and grooves of bearing rings, planetary/solar gears, and rough machining of drive shafts, ensuring deep cutting and high efficiency.

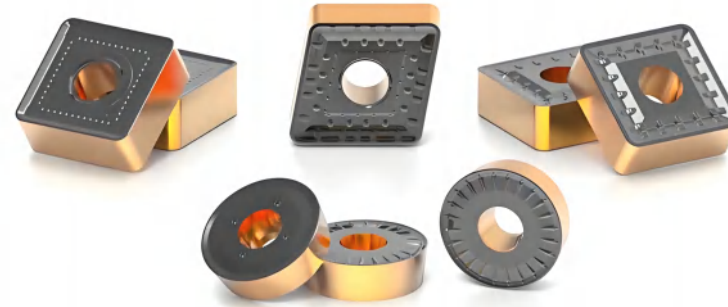

Main Shafts



Gears



## Post-Heat Hard Turning: CBN Inserts

Mainly used for post-heat machining of gear tooth outer diameters, end faces, and inner holes with hardness around HRC60, as well as precision machining of bearing raceways and planetary/solar gears, offering excellent wear resistance, stability, and surface finish.

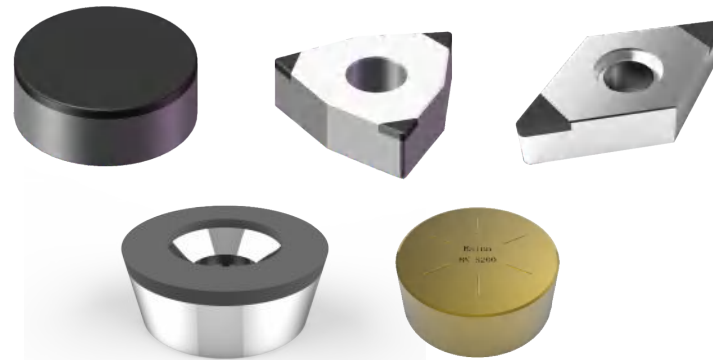

Bearings





# Gear Profile Milling: Rough Milling Cutter



## Application

- Profile Accuracy:  $\pm 0.1\text{mm}$ ; Module: 6-30
- Cutter Diameter: 200-500mm
- Cutting Parameters: Max cutting depth: 50mm, Cutting speed: 120-180m/min, Feed per tooth: 0.3-0.65mm/rev

## Features

- High-quality special steel with special surface treatment ensures cutter stability and long service life.
- Optimized design ensures even cutting force distribution among inserts, improving machining performance.
- Precision machining and reliable equipment control insert runout within 0.05mm, ensuring smoother cutting, longer insert life, and higher cutting speeds.
- Rough milling inserts feature side edges, allowing eight indexing positions per insert, reducing tool costs and adjustment time.





# Gear Profile Milling: Pre-Grind Milling Cutter



## Application

- Gear Accuracy: Grade 8-9; Module: 6-30
- Cutter Diameter: 200-500mm
- Cutting Parameters: Cutting speed: 130-200m/min, Feed/tooth: 0.25-0.45mm/rev

## Features

- High-quality special steel with special surface treatment ensures stable and long-lasting cutter performance.
- Optimized design ensures even cutting force distribution among inserts.
- Reliable machining processes and advanced equipment control insert runout within 0.005mm. Combined with superior insert materials, this ensures smoother cutting, longer tool life, and higher cutting speeds.
- Higher gear profile accuracy reduces subsequent grinding and time costs, improving gear machining efficiency.



# Gear Hobbing: High-Speed Pre-Grinding Hob



## Application

- Suitable for rough and semi-finishing machining of M5-M38 gears, achieving higher cutting speeds while ensuring safe and reliable production.
- Optimized tangential tooth arrangements (integral, modular, and other structures) can be customized based on customer needs to provide the best solutions.

## Insert Arrangement

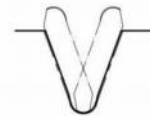

M6-7



M8-16

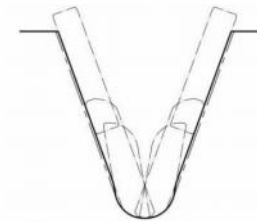

M18-24



# Gear Hobbing: High-Speed Pre-Grinding Hob

## High-Speed Gear Hobbing for External Teeth



### M18 Pre-Grinding Hob for Sun Gear Processing

Machine Processing Parameters

Cutting Depth: 35mm

Speed: S110

Feed: F3.5

Machine: Gleason

## Gear Profile Inspection Report

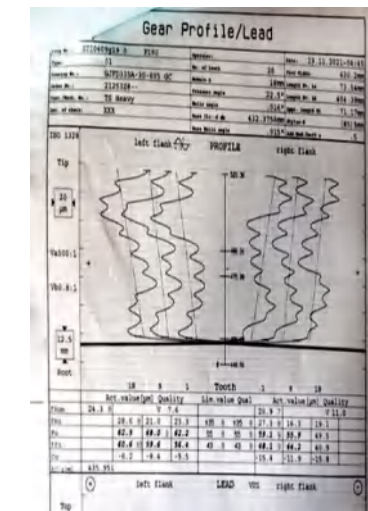
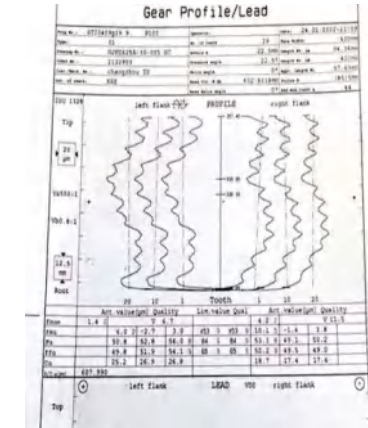





# Gear Shaping: Gear Shaper Cutter



## Application

- Suitable for machining small-module gears (M3.5-M10), achieving higher cutting speeds while ensuring safe and reliable production.
- Customized gear shaper cutter solutions are available based on customer needs.

## Features

- Indexable inserts eliminate the need for regrinding.
- Capable of machining internal teeth on small workpieces.
- V-shaped positioning ensures secure insert placement.





# Gear Shaping: Practical Application Case

Tool Parameters		Part: Gear Shaft			
Outer Diameter	450mm	Module	10	Gear Width	350mm
Effective Cutting Edges	8	Number of Teeth	56	Workpiece Material Hardness	42CrMo HRC40-41
Cutting Parameters		Comparison		Halnn	Domestic
Cutting Depth	0.3mm			Indexable	Solid HSS
Stroke	49m/min				
Circumferential Feed Rate	0.35mm/z 0.29mm/z(hss)			4-5 pieces/blade	2pieces/ regrind

1. Solved the problem of high material hardness and machining difficulty.
2. Addressed the issue of long regrinding cycles for HSS gear shaper cutters, reducing tool inventory pressure.



# Hole Machining: Crown Drill

## Product Feature:

- Polished cutter body chip grooves make chips easier to remove;
- The cylindrical fit of the cutter inserts head and cutter body ensures concentricity;
- Supports quick change drill insert. Without removing the drill inserts from the machine, and can quickly and easily change the drill inserts on the machine;
- The design with internal cooling holes allows for more thorough cooling during drilling, resulting in longer inserts life and easier chip removal.







# Staggered Tooth Thread Mill



## Machining Range

- Standard sizes M30-M64, thread depth of 2-2.5 times diameter,
- pitch 0.5-10mm.
- Suitable for threading in steel, stainless steel, cast iron, and aluminum.

## Advantages

- Multi-row staggered cutting edge design enables high-speed cutting and improved machining efficiency.
- Indexable tool design for large-diameter thread machining, reducing tooling costs.
- Internal cooling system for effective chip evacuation and cooling, enhancing machining stability.

## Bearings





# Staggered Tooth Thread Mill Holder Specifications

## Tool Holder Specifications

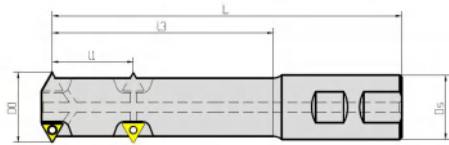
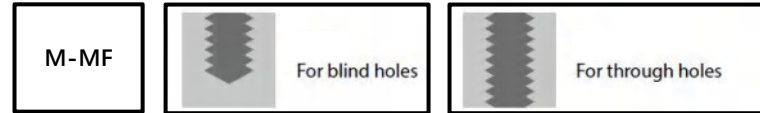

Fig 1

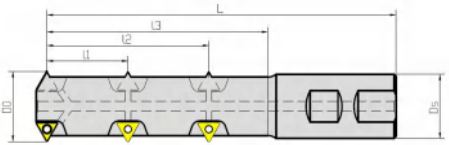

Fig 2

Specifications	DN	Pmax	D0	I1	I2	I3	L	Ds	z	Number	Model	Diagrams
ASTM02-0024W25G02-2T	M30	3.5	24	31.5	-	79.5	147	25	3	6	XCGX09...	Fig 1
ASTM02-0029W32G02-2T	M36	4.0	29	36.0	-	94.5	167	32	3	6	XCGX11...	
ASTM02-0035W32G03-2T	M42	4.5	35	40.5	-	110.5	180	32	3	6	XCGX14...	
ASTM02-0035W32G03-3T-156	M42	4.5	35	40.5	-	156	225	32	3	6	XCGX14...	
ASTM02-0040W40G04-2T	M48	5.0	40	50.0	-	127	211	40	3	6	XCGX09...	
ASTM02-0044W40G04-2T	M56	5.5	44	55.0	-	148	230	40	3	6	XCGX11...	
ASTM02-0054W50G04-2T	M64	6.0	54	60.0	-	168	260	50	3	6	XCGX11...	Fig 2
ASTM03-0029W32G02-3T	M36	4.0	29	24.0	48	76.5	149	32	3	9	XCGX11...	
ASTM03-0035W32G03-3T	M42	4.5	35	27.0	54	89.5	160	32	3	9	XCGX14...	
ASTM03-0040W40G04-3T	M48	5.0	40	30.0	60	103	187	40	3	9	XCGX14...	
ASTM03-0040W40G04-3T-120	M48	5.0	40	30.0	60	120	203	40	3	9	XCGX14...	
ASTM03-0044W40G04-3T	M56	5.5	44	33.0	66	119	201	40	3	9	XCGX14...	
ASTM03-0054W50G04-3T	M64	6.0	54	36.0	72	136	228	50	3	9	XCGX14...	



# Staggered Tooth Thread Mill Case 1



**Insert: TCGX090202-QF CPA220B**

**Holder: ASTM02-0024W25G02-3T**

Part Name: (Internal Gear Ring) 42CrMo HB330

Cutting Speed: 91m/min

Feed Rate: 0.24mm/rev (3T)

Cutting Depth: 3.5mm

Machining Mode: Wet Cutting

Tool Life Comparable to Previous Products

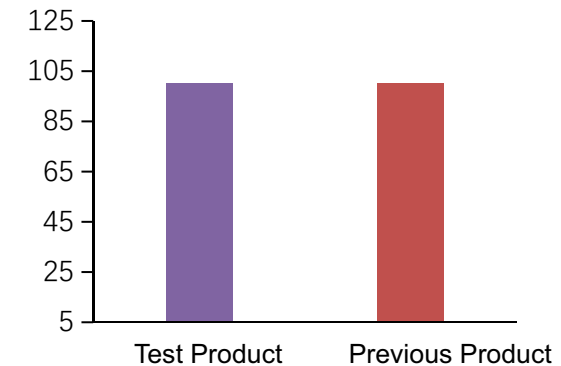

## Test Results & Evaluation :

1. Each edge processed 3 parts, with a lifespan of 2.7m per edge.
2. Efficiency and lifespan are comparable to previous products.
3. Significant cost advantage.





# Thread Tap

## Thread Tap: TIN M30/27/24/20/16/8 HSSE 6H

- Capable of machining high-hardness workpieces: HB280-330.
- Excellent chip management.
- Stable guiding performance.

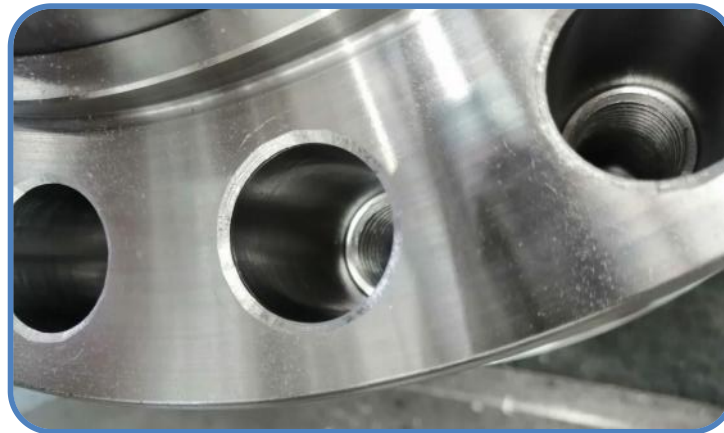

### Drive Shafts



R15



200000  
RPM



HSSE





# Hub: Milling / Hole Processing

## Milling Tools

- Multi-edged double-sided inserts with extremely high material removal rates.
- High feed rate processing to improve production efficiency.



## Hole Processing: Crown Drill

- Polished tool body chip evacuation groove design makes chip removal easier.
- The cylindrical fit between the drill head and body ensures concentricity.
- Quick-change drill head design allows for tool head replacement directly on the machine without removing the tool body, improving efficiency.
- Internal cooling hole design effectively enhances cooling performance, extends drill head lifespan, and ensures smooth chip removal.

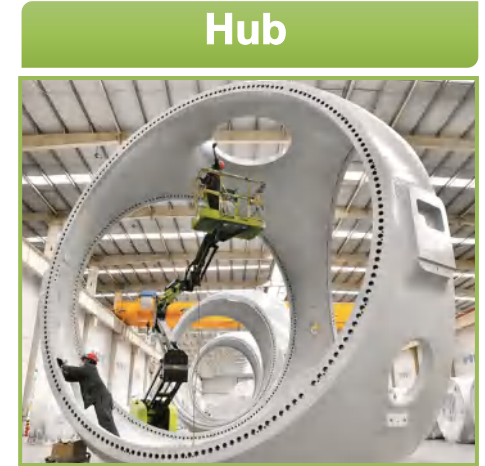



# Milling-Three-Edge Milling Cutter

## DFCN Non-Standard Series: Planet Carrier

Diameter range: D100-D400

Suitable for large overhang and deep cutting of steel and cast iron

### Features and Advantages

Utilizes low-resistance milling inserts to reduce cutting resistance during milling and minimize vibration.

Combined with a vibration-damping tool holder structure, it extends the tool overhang and machining range, suitable for machining installation surfaces of wind power gearboxes.

Planet Carrier

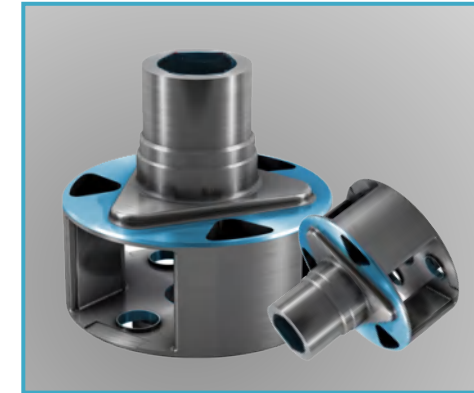





# Milling-Damping Milling Cutter

## Anti-Vibration Face Milling Tool Holder

Works with a low-resistance three-edge milling cutter for large overhang and deep cutting.

Achieves high cutting efficiency, ensuring a vibration-free machined surface with excellent surface quality.





# Boring-Damping Boring Tool Holder

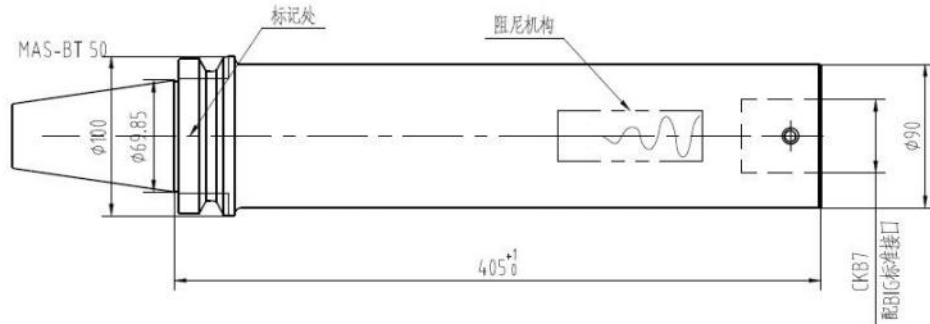

## Application

- Works with low-resistance lightweight rough and fine boring tools for large overhang and deep cutting.
- Achieves high cutting efficiency, ensuring a vibration-free machined surface with excellent surface quality.

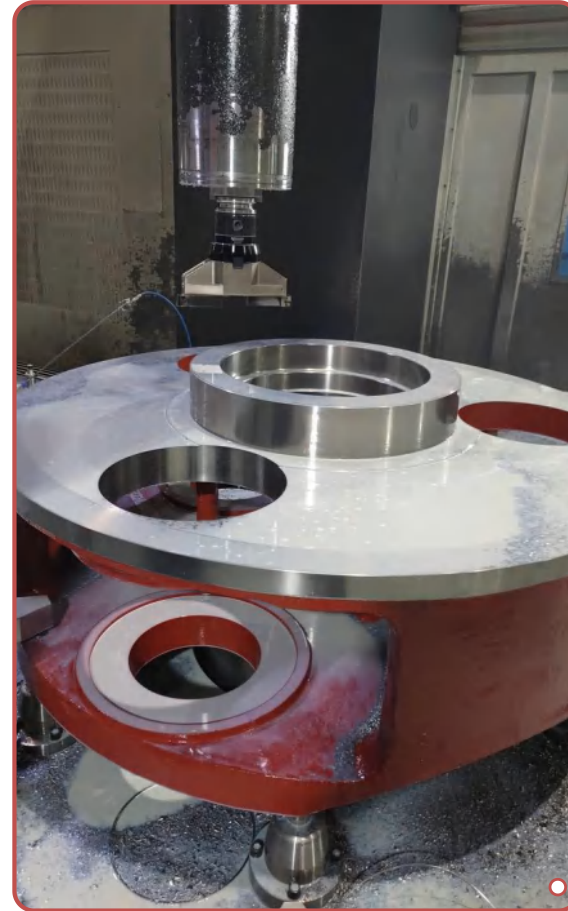



# Boring-CMR Rough Boring / CMB Fine Boring

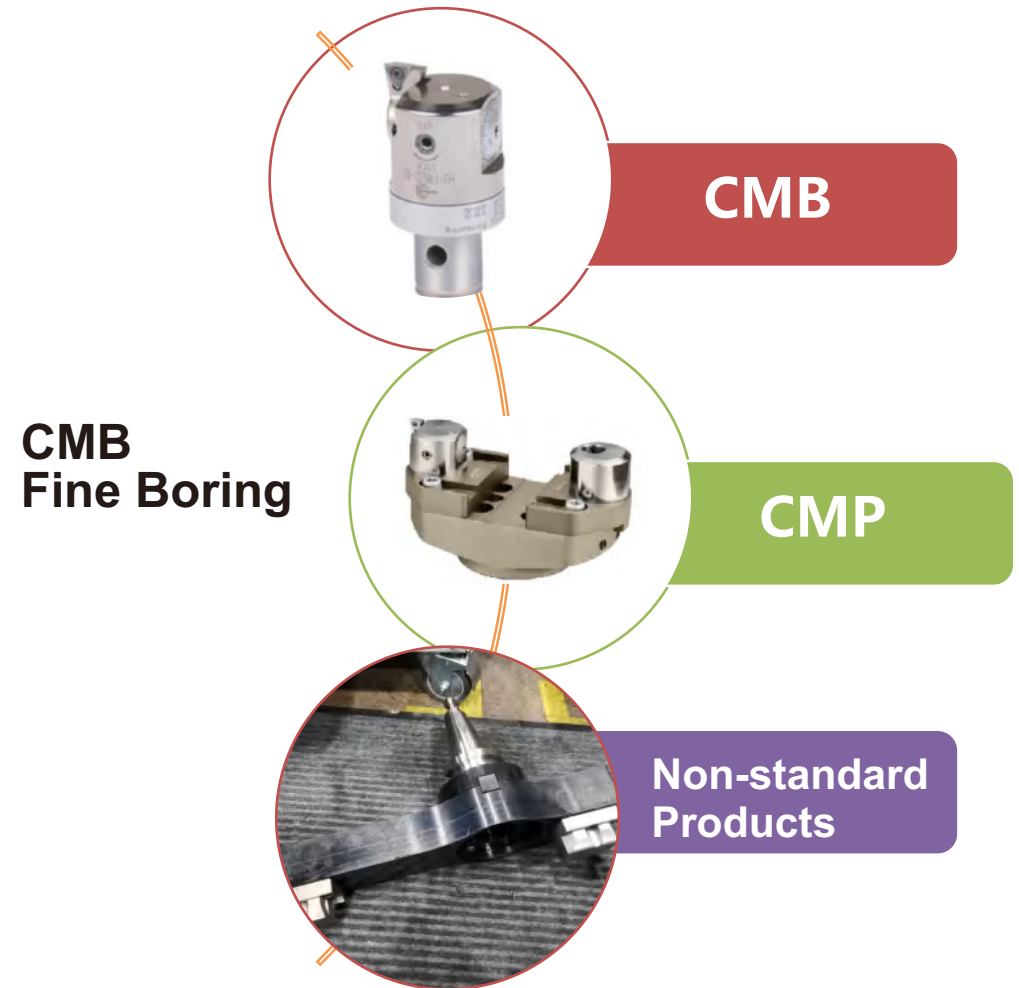
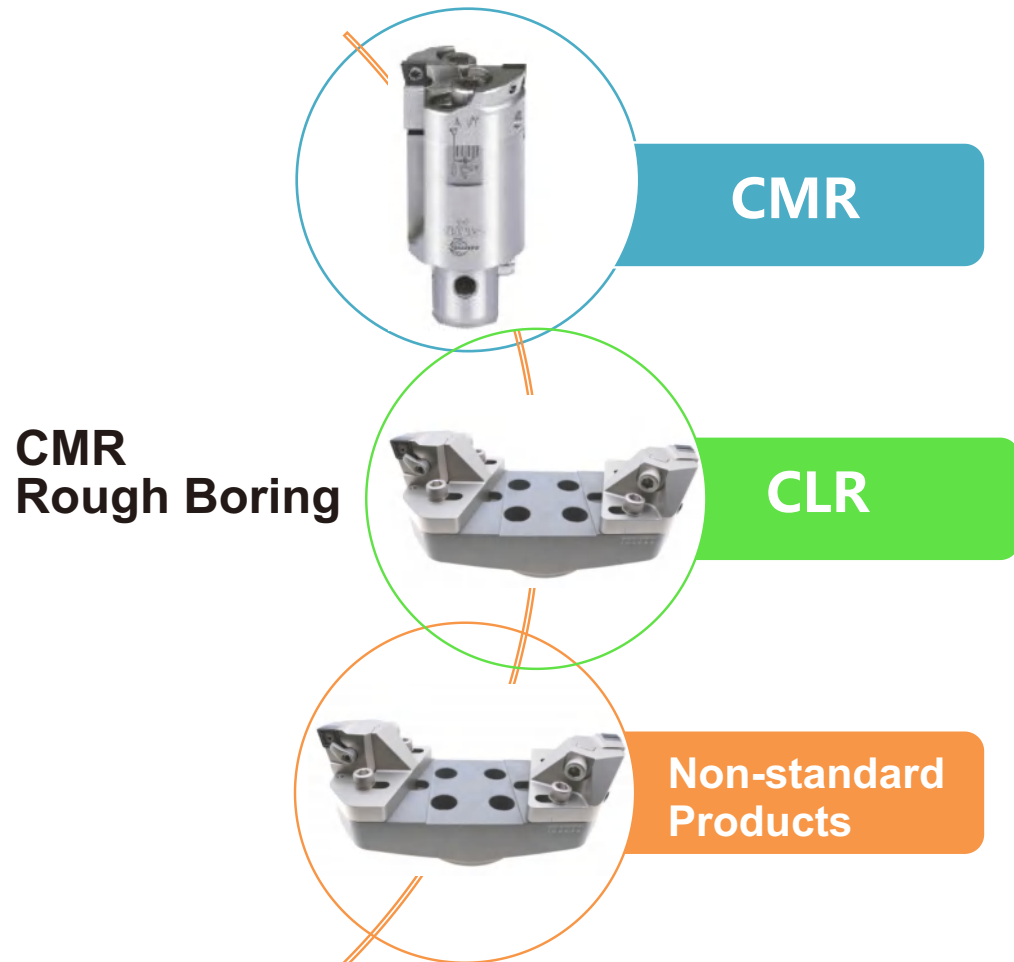



## Indexable Deep Hole Drill

- Tool diameter: D12-D40mm, hole roughness: <math><Ra2</math>
- Processing depth: Customized to customer requirements. Suitable for lathes, machining centers, and gun drilling machines.

### Compared to welded gun drills:

1. Feed rate increased by up to 2.5 times, significantly improving productivity.
2. Special 3-edge coated inserts combined with coated guide strips enhance tool life and ensure stable machining over longer periods.

### Compared to solid carbide drills:

1. Excellent chip-breaking performance ensures effective chip evacuation, preventing chip accumulation from affecting machining.
2. Ensures good hole straightness and surface roughness.
3. Replaceable insert design reduces tool change frequency, lowering machining costs.
4. No need for regrinding, reducing tool management and maintenance costs.

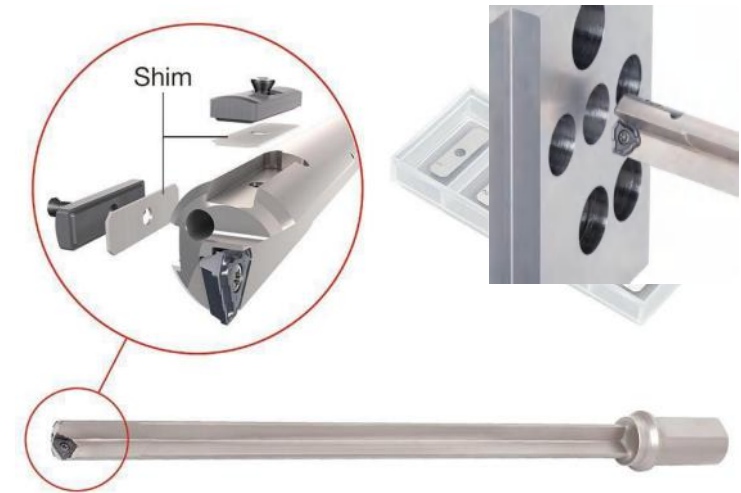



# Hydraulic Valve-Hole Processing

## Advantages

- Surface roughness for hydraulic valve block mounting valves and flanges reaches Ra0.4.
- Perpendicularity tolerance between the thread holes for pipe fittings and their outer contact surfaces meets grade 8 requirements.
- Surface roughness of installation holes for threaded cartridge valves is Ra0.8.
- Halnn can design customized tool solutions based on on-site machining conditions to meet customer needs.

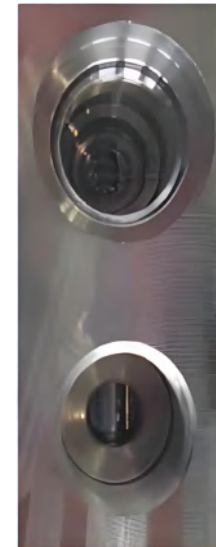





# Blade: Hole Processing

## U Drill + PCD Inserts

Halnn PCD inserts and matching tool holders effectively suppress burrs and delamination during drilling. The high hardness and wear resistance of Halnn PCD inserts ensure stable cutting performance, meeting the high-volume, high-efficiency, and high-precision machining requirements for composite materials.



Blade





# PRESENTATION COMPLETED

If you have any questions, please feel free to contact us.....

Asia: [asia@halnn-group.com](mailto:asia@halnn-group.com)

Europe: [europe@halnn-group.com](mailto:europe@halnn-group.com)

Americas: [americas@halnn-group.com](mailto:americas@halnn-group.com)

