

高温合金/硬钢/铸铁加工用陶瓷刀片

Ceramic inserts for machining of superalloy/hard steel/cast iron

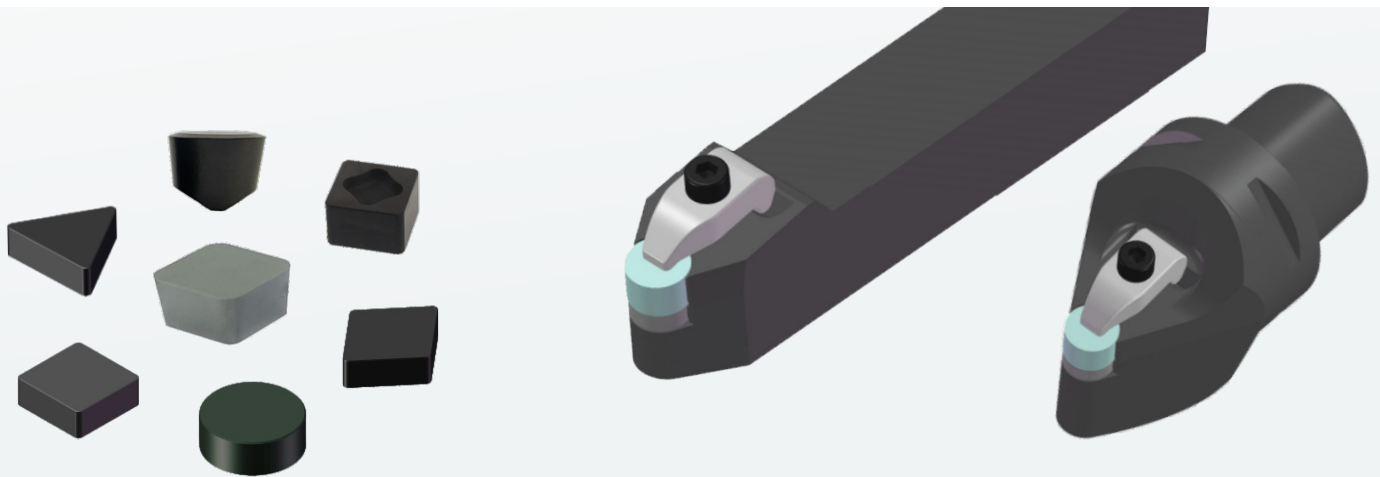

满足高温合金，淬硬钢/轴承钢，铸铁的高速加工
High-speed machining of superalloy, hardened/bearing steels and cast iron.

- ★ 耐磨性好，耐高温，可实现稳定加工；
Good wear resistance and high temperature resistance for stable machining;
- ★ 耐磨损和抗冲击性兼备，金属去除率远超硬质合金刀具；
Combination of wear and impact resistance, with metal removal rates far exceeding those of carbide tools;
- ★ 可提供各种标准和非标准的刀片。
Various standard and non-standard inserts are available.



目录 CONTENTS

| | | |
|--|-------|----|
| 陶瓷刀片型号 Ceramic insert type | | 4 |
| 通用车削刀杆 Universal turning tool holder | | 11 |
| 高温合金车削专用刀杆 Superalloy turning special tool holder | | 15 |
| CAPTO车削刀杆 CAPTO turning tool holder | | 17 |
| 高效高精度车削刀杆 High-efficiency and high-precision turning tool holder | | 25 |
| 高效率车削刀杆 High efficiency turning tool holder | | 30 |

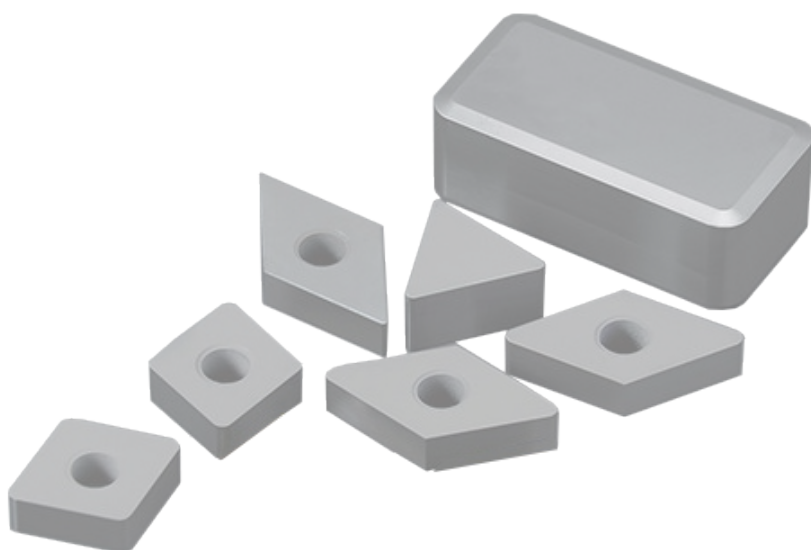

SH100/SH200

高温合金铣削和粗车推荐材质
Recommended materials for milling and roughing of superalloy

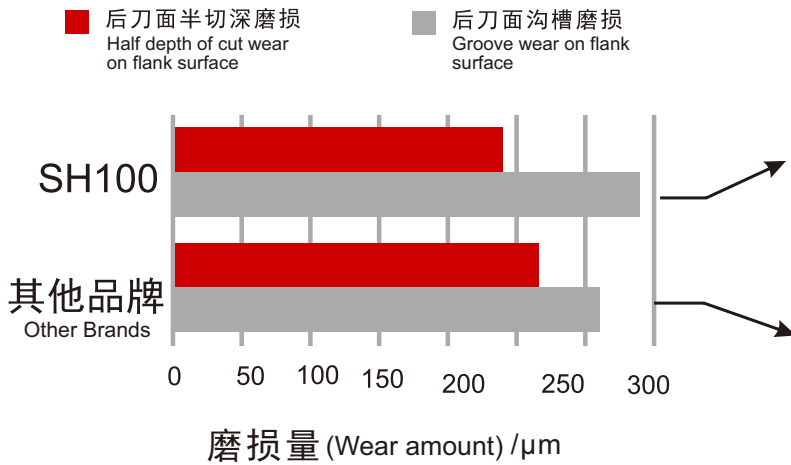

刀具磨损形貌
Tool wear morphology

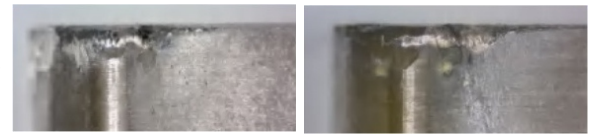

SH100

其他品牌
Other Brands

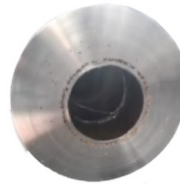

SH100加工后表面质量
Surface quality after machining by SH100

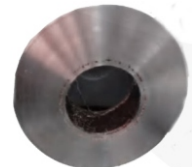

其他品牌加工后表面质量
Surface quality after machining by other brands

工件材质: 高温合金 切削状态: 干车削
Working piece: superalloy Cutting status: dry turning
线速度: 300m/min, 进给量: 0.1mm/r, 切深: 1.5mm
Cutting speed: 300m/min, Feed rate: 0.1mm/r, Depth of Cut: 1.5mm

S100/S200

高温合金车削推荐材质, 可添加涂层
Suitable for turning superalloy, Coating can be applied

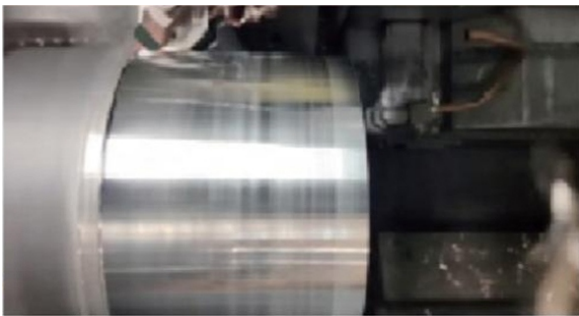

工件材质: 高温合金 切削状态: 干车削
Working piece: superalloy Cutting status: dry turning
线速度: 300m/min, 进给量: 0.1mm/r, 切深: 0.5mm
Cutting speed: 300m/min, Feed rate: 0.1mm/r, Depth of Cut: 0.5mm

后刀面半切深磨损
Half depth of cut wear on tool flank

后刀面沟槽磨损
Groove wear on tool flank

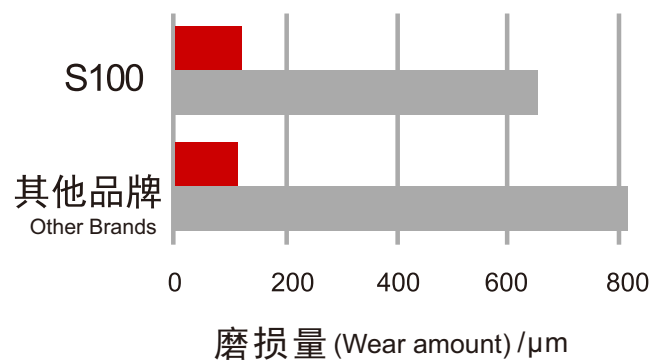

刀具磨损形貌
Tool wear morphology

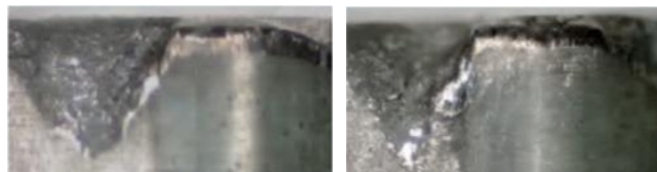

S100

其他品牌
Other Brands

H100/H200

高硬度钢/高硬度铸铁精加工/半精加工推荐材质
Recommended materials for finishing and semi-finishing of high-hardness steel/high-hardness cast iron



工件材质: 轴承钢 切削状态: 干车削
线速度: 150m/min, 进给量: 0.1mm/r, 切深: 0.2mm
Working piece: Bearing steel Cutting status: dry turning
Cutting speed: 150m/min, Feed rate: 0.1mm/r, Depth of Cut: 0.2mm

■ 后刀面半切深磨损
Half depth of cut wear on tool flank
■ 后刀面沟槽磨损
Groove wear on tool flank

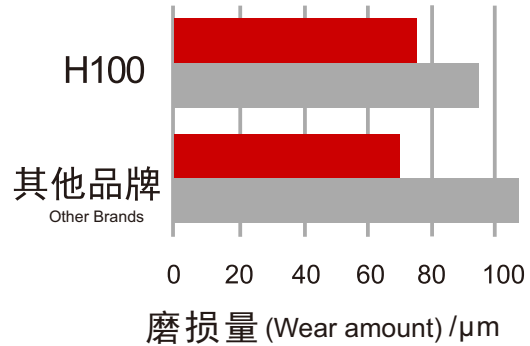

刀具磨损形貌
Tool wear morphology

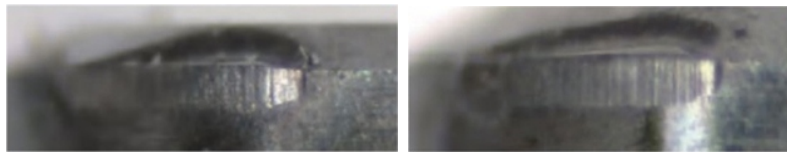

H100

其他品牌
Other Brands

H100C/H200C (涂层coated)

高硬度钢和球墨铸铁的精加工或半精加工推荐材质

Recommended materials for finishing/semi-finishing of high hardness steels and ductile iron

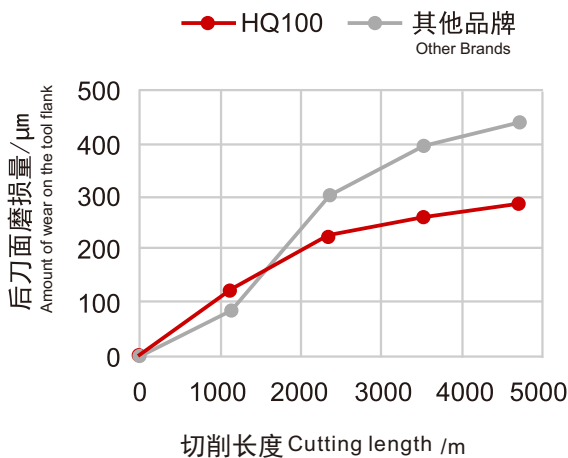

工件材质: 轴承钢 切削状态: 干车削
线速度: 150m/min, 进给量: 0.1mm/r, 切深: 0.2mm
Working piece: Bearing steel Cutting status: dry turning
Cutting speed: 150m/min, Feed rate: 0.1mm/r, Depth of Cut: 0.2mm

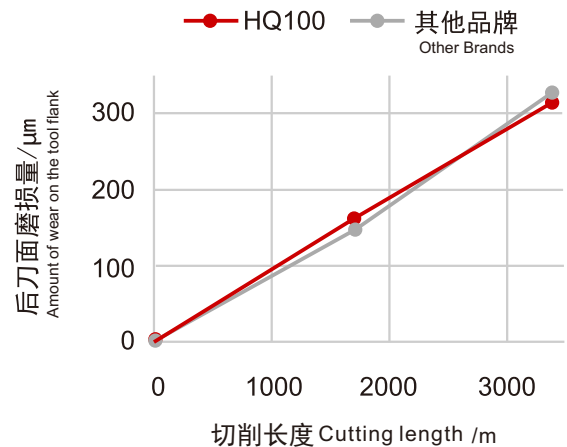

工件材质: 高硬度球墨铸铁 切削状态: 干车削
线速度: 200m/min, 进给量: 0.1mm/r, 切深: 0.5mm
Working piece: High hardness ductile iron Cutting status: dry turning
Cutting speed: 200m/min, Feed rate: 0.1mm/r, Depth of Cut: 0.5mm

KD100/KD200/KD300

灰铸铁/球磨铸铁/合金铸铁精加工推荐材质

Grey cast iron / ductile cast iron / alloy cast iron finishing recommended materials

- 后刀面半切深磨损
Half depth of cut wear on tool flank
- 后刀面沟槽磨损
Groove wear on tool flank

刀具磨损形貌
Tool wear morphology

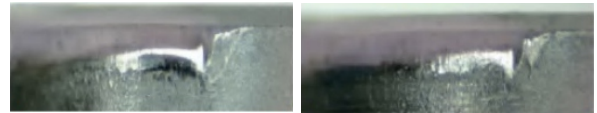
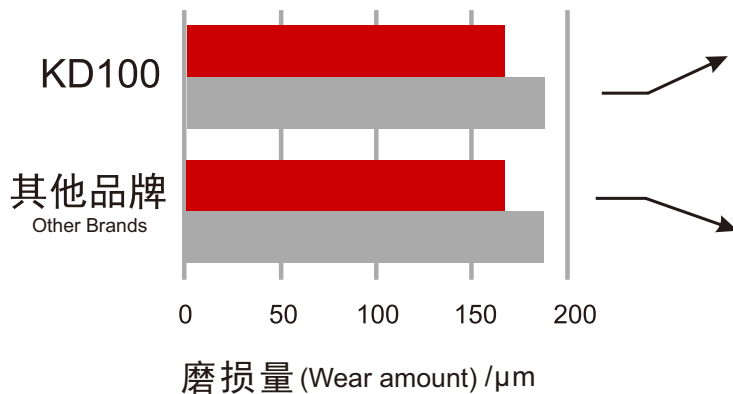

KD100

其他品牌
Other Brands



合金铸铁
Alloy cast iron



铸铁缸套
Cast Iron Cylinder Liner

工件材质: 灰铸铁 切削状态: 干车削
Working piece: Grey cast iron Cutting status: dry turning
线速度: 300m/min, 进给量: 0.1mm/r,
Cutting speed: 300m/min, Feed rate: 0.1mm/r,
切深: 0.5mm
Depth of Cut: 0.5mm

KN100/KN200

高硬度钢和球墨铸铁的精加工或半精加工推荐材质

Recommended materials for finishing/semi-finishing of high hardness steels and ductile iron

- 后刀面半切深磨损
Half depth of cut wear on tool flank
- 后刀面刀尖磨损
Groove wear on tool flank

刀具磨损形貌
Tool wear morphology

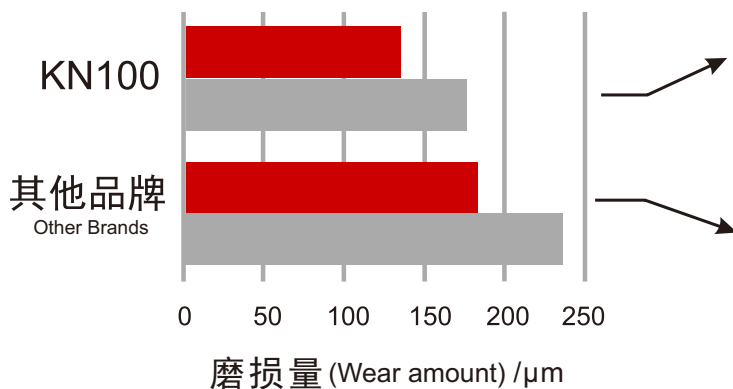

KN100

其他品牌
Other Brands

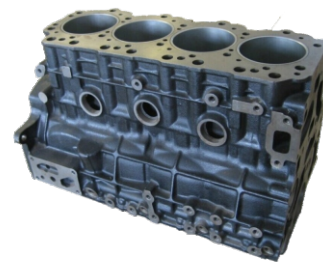

灰铸铁发动机缸体
Grey cast iron engine block

工件材质: 灰铸铁 切削状态: 干车削
Working piece: Grey cast iron Cutting status: dry turning
线速度: 500m/min, 进给量: 0.1mm/r,
Cutting speed: 500m/min, Feed rate: 0.1mm/r,
切深: 0.5mm
Depth of Cut: 0.5mm

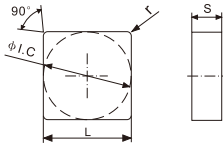
| 型号 Type | 尺寸参数 Dimension (mm) | | | | 牌号 Grades | | | | | | | |
|------------|---------------------|--------|------|-----|----------------|--------------|----------------|--------------|----------------|----------------------|----------------|--|
| | L | φI.C | S | r | SH100 SH200 | S100 S200 | S100C S200C | H100 H200 | H100C H200C | KD100 KD200/KD300 | KN100 KN200 | |
| SNGN090304 | 9.525 | 9.525 | 3.18 | 0.4 | ○ | ○ | ○ | ● | ● | ● | ○ | |
| SNGN090308 | 9.525 | 9.525 | 3.18 | 0.8 | ○ | ○ | ○ | ● | ● | ● | ○ | |
| SNGN090312 | 9.525 | 9.525 | 3.18 | 1.2 | ○ | ○ | ○ | ● | ● | ● | ○ | |
| SNGN090404 | 9.525 | 9.525 | 4.76 | 0.4 | ○ | ○ | ○ | ● | ● | ● | ○ | |
| SNGN090408 | 9.525 | 9.525 | 4.76 | 0.8 | ○ | ○ | ○ | ● | ● | ● | ○ | |
| SNGN090412 | 9.525 | 9.525 | 4.76 | 1.2 | ○ | ○ | ○ | ● | ● | ● | ○ | |
| SNGN120404 | 12.7 | 12.7 | 4.76 | 0.4 | ○ | ● | ● | ● | ● | ● | ○ | |
| SNGN120408 | 12.7 | 12.7 | 4.76 | 0.8 | ○ | ● | ● | ● | ● | ● | ○ | |
| SNGN120412 | 12.7 | 12.7 | 4.76 | 1.2 | ○ | ● | ● | ● | ● | ● | ○ | |
| SNGN120712 | 12.7 | 12.7 | 7.94 | 1.2 | ○ | ● | ● | ● | ● | ● | ○ | |
| SNGN120716 | 12.7 | 12.7 | 7.94 | 1.6 | ○ | ● | ● | ● | ● | ● | ○ | |
| SNGN150716 | 15.875 | 15.875 | 7.94 | 1.6 | ○ | ● | ● | ● | ○ | ○ | ○ | |
| SNGN201020 | 20 | 20 | 10 | 2.0 | ○ | ● | ● | ○ | ○ | ○ | ○ | |

| 型号 Type | 尺寸参数 Dimension (mm) | | | | 牌号 Grades | | | | | | | |
|------------|---------------------|-------|------|-----|----------------|--------------|----------------|--------------|----------------|----------------------|----------------|--|
| | L | φI.C | S | r | SH100 SH200 | S100 S200 | S100C S200C | H100 H200 | H100C H200C | KD100 KD200/KD300 | KN100 KN200 | |
| CNGN090404 | 9.7 | 9.525 | 4.76 | 0.4 | ○ | ○ | ○ | ○ | ○ | ○ | ○ | |
| CNGN090408 | 9.7 | 9.525 | 4.76 | 0.8 | ○ | ○ | ○ | ○ | ○ | ○ | ○ | |
| CNGN090412 | 9.7 | 9.525 | 4.76 | 1.2 | ○ | ○ | ○ | ○ | ○ | ○ | ○ | |
| CNGN120404 | 12.9 | 12.7 | 4.76 | 0.4 | ○ | ● | ● | ● | ● | ● | ○ | |
| CNGN120408 | 12.9 | 12.7 | 4.76 | 0.8 | ○ | ● | ● | ● | ● | ● | ○ | |
| CNGN120412 | 12.9 | 12.7 | 4.76 | 1.2 | ○ | ● | ● | ● | ● | ● | ○ | |
| CNGN120416 | 12.9 | 12.7 | 4.76 | 1.6 | ○ | ● | ● | ● | ● | ● | ○ | |
| CNGN120704 | 12.9 | 12.7 | 7.94 | 0.4 | ○ | ● | ● | ● | ● | ● | ○ | |
| CNGN120708 | 12.9 | 12.7 | 7.94 | 0.8 | ○ | ● | ● | ● | ● | ● | ○ | |
| CNGN120712 | 12.9 | 12.7 | 7.94 | 1.2 | ○ | ● | ● | ● | ● | ● | ○ | |
| CNGN120716 | 12.9 | 12.7 | 7.94 | 1.6 | ○ | ● | ● | ● | ● | ● | ○ | |

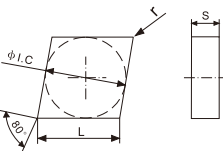

| 型号 Type | 尺寸参数 Dimension (mm) | | | | 牌号 Grades | | | | | | |
|------------|-----------------------|--------|------|---|----------------|--------------|----------------|--------------|----------------|-----------------------|----------------|
| | L | φ I.C | s | r | SH100 SH200 | S100 S200 | S100C S200C | H100 H200 | H100C H200C | KD100 KD200/ KD300 | KN100 KN200 |
| RNGN060400 | | 6.35 | 4.76 | | ● | | ◎ | ◎ | ◎ | ◎ | ◎ |
| RNGN090300 | | 9.525 | 3.18 | | ● | ◎ | ◎ | ● | ● | ● | ◎ |
| RNGN090400 | | 9.525 | 4.76 | | ● | ● | ● | ● | ● | ● | ◎ |
| RNGN090700 | | 9.525 | 7.94 | | ● | ● | ● | ● | ● | ● | ◎ |
| RNGN120400 | | 12.7 | 4.76 | | ● | ● | ● | ● | ● | ● | ◎ |
| RNGN120600 | | 12.7 | 6.35 | | ● | ● | ● | ● | ● | ● | ◎ |
| RNGN120700 | | 12.7 | 7.94 | | ● | ● | ● | ● | ● | ● | ◎ |
| RNGN150700 | | 15.875 | 7.94 | | ● | ● | ● | ● | ◎ | ◎ | ◎ |
| RNGN200800 | | 20 | 8 | | ● | ● | ● | ● | ◎ | ◎ | ◎ |
| RNGN201000 | | 20 | 10 | | ● | ● | ● | ● | ◎ | ◎ | ◎ |
| RNGN251000 | | 25.4 | 10 | | ● | ● | ● | ● | ◎ | ◎ | ◎ |
| RNGN251200 | | 25.4 | 12 | | ● | ● | ● | ● | ◎ | ◎ | ◎ |



| 型号 Type | 尺寸参数 Dimension (mm) | | | | 牌号 Grades | | | | | | |
|-------------|-----------------------|--------|------|---|----------------|--------------|----------------|--------------|----------------|-----------------------|----------------|
| | L | φ I.C | s | r | SH100 SH200 | S100 S200 | S100C S200C | H100 H200 | H100C H200C | KD100 KD200/ KD300 | KN100 KN200 |
| RCGX060400Y | | 6.35 | 4.76 | | ◎ | ● | ● | ◎ | ● | ● | ◎ |
| RCGX060500Y | | 6.35 | 5.56 | | ◎ | ● | ● | ◎ | ● | ● | ◎ |
| RCGX060600Y | | 6.35 | 6.35 | | ◎ | ● | ● | ◎ | ● | ● | ◎ |
| RCGX060700Y | | 6.35 | 7.94 | | ◎ | ● | ● | ◎ | ● | ● | ◎ |
| RCGX090700Y | | 9.525 | 7.94 | | ◎ | ● | ● | ◎ | ● | ● | ◎ |
| RCGX120700Y | | 12.7 | 7.94 | | ◎ | ● | ● | ◎ | ● | ● | ◎ |
| RCGX151000Y | | 15.875 | 10 | | ◎ | ◎ | ◎ | ◎ | ◎ | ◎ | ◎ |
| RCGX191000Y | | 19.05 | 10 | | ◎ | ◎ | ◎ | ◎ | ◎ | ◎ | ◎ |
| RCGX201200Y | | 20 | 12 | | ◎ | ◎ | ◎ | ◎ | ◎ | ◎ | ◎ |
| RCGX251200Y | | 25.4 | 12 | | ◎ | ◎ | ◎ | ◎ | ◎ | ◎ | ◎ |



| 型号 Type | 尺寸参数 Dimension (mm) | | | | 牌号 Grades | | | | | | |
|------------|-----------------------|--------|------|---|----------------|--------------|----------------|--------------|----------------|----------------------|----------------|
| | L | φ I.C | S | r | SH100 SH200 | S100 S200 | S100C S200C | H100 H200 | H100C H200C | KD100 KD200/KD300 | KN100 KN200 |
| RCGN060400 | | 6.35 | 4.76 | | ● | ● | ● | ● | ○ | ● | ○ |
| RCGN090400 | | 9.525 | 4.76 | | ● | ● | ● | ● | ○ | ● | ○ |
| RCGN090700 | | 9.525 | 7.94 | | ● | ● | ● | ● | ○ | ● | ○ |
| RCGN120700 | | 12.7 | 7.94 | | ● | ● | ● | ● | ○ | ● | ○ |
| RCGN150700 | | 15.875 | 7.94 | | ● | ● | ● | ● | ○ | ● | ○ |
| RCGN190700 | | 19.05 | 7.94 | | ● | ● | ● | ● | ○ | ● | ○ |



| 型号 Type | 尺寸参数 Dimension (mm) | | | | 牌号 Grades | | | | | | |
|-------------|-----------------------|--------|------|-----|----------------|--------------|----------------|--------------|----------------|----------------------|----------------|
| | L | φ I.C | S | b | SH100 SH200 | S100 S200 | S100C S200C | H100 H200 | H100C H200C | KD100 KD200/KD300 | KN100 KN200 |
| RCGX060400V | | 6.35 | 4.76 | 0.8 | ○ | ● | ● | ○ | ● | ● | ○ |
| RCGX060500V | | 6.35 | 5.56 | 0.8 | ○ | ● | ● | ○ | ● | ● | ○ |
| RCGX060600V | | 6.35 | 6.35 | 0.8 | ○ | ● | ● | ○ | ● | ● | ○ |
| RCGX090700V | | 9.525 | 7.94 | 1 | ○ | ● | ● | ○ | ● | ● | ○ |
| RCGX120700V | | 12.7 | 7.94 | 2 | ○ | ● | ● | ○ | ● | ● | ○ |
| RCGX151000V | | 15.875 | 10 | 2 | ○ | ● | ● | ○ | ○ | ● | ○ |
| RCGX191000V | | 19.05 | 10 | 2 | ○ | ● | ● | ○ | ○ | ● | ○ |
| RCGX201200V | | 20 | 12 | 2 | ○ | ● | ● | ○ | ○ | ● | ○ |
| RCGX251200V | | 25.4 | 12 | 2 | ○ | ● | ● | ○ | ○ | ● | ○ |



| 型号 Type | 尺寸参数 Dimension (mm) | | | | 牌号 Grades | | | | | | |
|------------|-----------------------|-------|------|-----|----------------|--------------|----------------|--------------|----------------|----------------------|----------------|
| | L | φ I.C | S | r | SH100 SH200 | S100 S200 | S100C S200C | H100 H200 | H100C H200C | KD100 KD200/KD300 | KN100 KN200 |
| DNGN110404 | 11.6 | 9.525 | 4.76 | 0.4 | ○ | ● | ● | ● | ● | ● | ○ |
| DNGN110408 | 11.6 | 9.525 | 4.76 | 0.8 | ○ | ● | ● | ● | ● | ● | ○ |
| DNGN110412 | 11.6 | 9.525 | 4.76 | 1.2 | ○ | ● | ● | ● | ● | ● | ○ |



| 型号 Type | 尺寸参数 Dimension (mm) | | | | 牌号 Grades | | | | | | |
|------------|-----------------------|-------|------|-----|----------------|--------------|----------------|--------------|----------------|-----------------------|----------------|
| | L | φ I.C | S | r | SH100 SH200 | S100 S200 | S100C S200C | H100 H200 | H100C H200C | KD100 KD200/ KD300 | KN100 KN200 |
| SCGN090304 | 9.525 | 9.525 | 3.18 | 0.4 | ○ | ○ | ● | ○ | ● | ● | ○ |
| SCGN090308 | 9.525 | 9.525 | 3.18 | 0.8 | ○ | ○ | ● | ○ | ● | ● | ○ |
| SCGN090312 | 9.525 | 9.525 | 3.18 | 1.2 | ○ | ○ | ● | ○ | ● | ● | ○ |
| SCGN090404 | 9.525 | 9.525 | 4.76 | 0.4 | ○ | ○ | ● | ○ | ● | ● | ○ |
| SCGN090408 | 9.525 | 9.525 | 4.76 | 0.8 | ○ | ○ | ● | ○ | ● | ● | ○ |
| SCGN090412 | 9.525 | 9.525 | 4.76 | 1.2 | ○ | ○ | ● | ○ | ● | ● | ○ |



| 型号 Type | 尺寸参数 Dimension (mm) | | | | 牌号 Grades | | | | | | |
|------------|-----------------------|-------|------|-----|----------------|--------------|----------------|--------------|----------------|-----------------------|----------------|
| | L | φ I.C | S | r | SH100 SH200 | S100 S200 | S100C S200C | H100 H200 | H100C H200C | KD100 KD200/ KD300 | KN100 KN200 |
| TNGN110304 | 11 | 6.35 | 3.18 | 0.4 | ○ | ○ | ○ | ○ | ○ | ○ | ○ |
| TNGN110308 | 11 | 6.35 | 3.18 | 0.8 | ○ | ○ | ○ | ○ | ○ | ○ | ○ |
| TNGN110312 | 11 | 6.35 | 3.18 | 1.2 | ○ | ○ | ○ | ○ | ○ | ○ | ○ |
| TNGN160404 | 16.5 | 9.525 | 4.76 | 0.4 | ○ | ○ | ○ | ○ | ○ | ○ | ○ |
| TNGN160408 | 16.5 | 9.525 | 4.76 | 0.8 | ○ | ○ | ○ | ○ | ○ | ○ | ○ |
| TNGN160412 | 16.5 | 9.525 | 4.76 | 1.2 | ○ | ○ | ○ | ○ | ○ | ○ | ○ |



| 型号 Type | 尺寸参数 Dimension (mm) | | | | 牌号 Grades | | | | | | |
|------------|-----------------------|-------|------|-----|----------------|--------------|----------------|--------------|----------------|-----------------------|----------------|
| | L | φ I.C | S | r | SH100 SH200 | S100 S200 | S100C S200C | H100 H200 | H100C H200C | KD100 KD200/ KD300 | KN100 KN200 |
| CNG0120704 | 12.9 | 12.7 | 7.94 | 0.4 | ○ | ○ | ○ | ○ | ● | ○ | ○ |
| CNG0120708 | 12.9 | 12.7 | 7.94 | 0.8 | ○ | ○ | ○ | ○ | ● | ○ | ○ |
| CNG0120712 | 12.9 | 12.7 | 7.94 | 1.2 | ○ | ○ | ○ | ○ | ● | ○ | ○ |



| 型号 Type | 尺寸参数 Dimension (mm) | | | | 牌号 Grades | | | | | | |
|------------|-----------------------|-------|------|-----|----------------|--------------|----------------|--------------|----------------|----------------------|----------------|
| | L | φ I.C | S | r | SH100 SH200 | S100 S200 | S100C S200C | H100 H200 | H100C H200C | KD100 KD200/KD300 | KN100 KN200 |
| CNGL120708 | 12.9 | 12.7 | 7.94 | 0.8 | ○ | ○ | ○ | ○ | ● | ○ | ○ |
| CNGL120712 | 12.9 | 12.7 | 7.94 | 1.2 | ○ | ○ | ○ | ○ | ● | ○ | ○ |
| CNGL120716 | 12.9 | 12.7 | 7.94 | 1.6 | ○ | ○ | ○ | ○ | ● | ○ | ○ |



| 型号 Type | 尺寸参数 Dimension (mm) | | | | 牌号 Grades | | | | | | |
|------------|-----------------------|-------|------|-----|----------------|--------------|----------------|--------------|----------------|----------------------|----------------|
| | L | φ I.C | S | r | SH100 SH200 | S100 S200 | S100C S200C | H100 H200 | H100C H200C | KD100 KD200/KD300 | KN100 KN200 |
| TNG0160604 | 16.5 | 9.525 | 6.35 | 0.4 | ○ | ○ | ○ | ○ | ● | ○ | ○ |
| TNG0160608 | 16.5 | 9.525 | 6.35 | 0.8 | ○ | ○ | ○ | ○ | ● | ○ | ○ |
| TNG0160612 | 16.5 | 9.525 | 6.35 | 1.2 | ○ | ○ | ○ | ○ | ● | ○ | ○ |



| 型号 Type | 尺寸参数 Dimension (mm) | | | | 牌号 Grades | | | | | | |
|------------|-----------------------|--------|------|---|----------------|--------------|----------------|--------------|----------------|----------------------|----------------|
| | L | φ I.C | S | r | SH100 SH200 | S100 S200 | S100C S200C | H100 H200 | H100C H200C | KD100 KD200/KD300 | KN100 KN200 |
| RNGS090600 | | 9.525 | 6.35 | | ○ | ○ | ○ | ○ | ● | ○ | ○ |
| RNGS120700 | | 12.7 | 7.94 | | ○ | ○ | ○ | ○ | ● | ○ | ○ |
| RNGS150700 | | 15.875 | 7.94 | | ○ | ○ | ○ | ○ | ● | ○ | ○ |
| RNGS201000 | | 20 | 10 | | ○ | ○ | ○ | ○ | ● | ○ | ○ |



| 型号 Type | 尺寸参数 Dimension (mm) | | | | 牌号 Grades | | | | | | |
|------------|-----------------------|-------|------|-----|----------------|--------------|----------------|--------------|----------------|----------------------|----------------|
| | L | φ I.C | S | r | SH100 SH200 | S100 S200 | S100C S200C | H100 H200 | H100C H200C | KD100 KD200/KD300 | KN100 KN200 |
| DNGL110604 | 11.6 | 9.525 | 6.35 | 0.4 | ○ | ○ | ○ | ○ | ● | ○ | ○ |
| DNGL110608 | 11.6 | 9.525 | 6.35 | 0.8 | ○ | ○ | ○ | ○ | ● | ○ | ○ |
| DNGL110612 | 11.6 | 9.525 | 6.35 | 1.2 | ○ | ○ | ○ | ○ | ● | ○ | ○ |



| 型号 Type | 尺寸参数 Dimension (mm) | | | | 牌号 Grades | | | | | | |
|------------|-----------------------|--------|------|---|----------------|--------------|----------------|--------------|----------------|----------------------|----------------|
| | L | φ I.C | S | r | SH100 SH200 | S100 S200 | S100C S200C | H100 H200 | H100C H200C | KD100 KD200/KD300 | KN100 KN200 |
| RCG0090600 | | 9.525 | 6.35 | | ○ | ○ | ○ | ○ | ● | ○ | ○ |
| RCG0120700 | | 12.7 | 7.94 | | ○ | ○ | ○ | ○ | ● | ○ | ○ |
| RCG0150700 | | 15.875 | 7.94 | | ○ | ○ | ○ | ○ | ● | ○ | ○ |
| RCG0201000 | | 20 | 10 | | ○ | ○ | ○ | ○ | ● | ○ | ○ |



| 型号 Type | 尺寸参数 Dimension (mm) | | | | 牌号 Grades | | | | | | |
|------------|-----------------------|--------|------|---|----------------|--------------|----------------|--------------|----------------|----------------------|----------------|
| | L | φ I.C | S | r | SH100 SH200 | S100 S200 | S100C S200C | H100 H200 | H100C H200C | KD100 KD200/KD300 | KN100 KN200 |
| RCGS090600 | | 9.525 | 6.35 | | ○ | ○ | ○ | ○ | ● | ○ | ○ |
| RCGS120700 | | 12.7 | 7.94 | | ○ | ○ | ○ | ○ | ● | ○ | ○ |
| RCGS150700 | | 15.875 | 7.94 | | ○ | ○ | ○ | ○ | ● | ○ | ○ |
| RCGS201000 | | 20 | 10 | | ○ | ○ | ○ | ○ | ● | ○ | ○ |



| 型号 Type | 尺寸参数 Dimension (mm) | | | | | 牌号 Grades | | | | | | |
|------------|---------------------|------------|----------|------|-----|----------------|--------------|----------------|--------------|----------------|----------------------|----------------|
| | L | ϕ I.C | ϕ d | S | r | SH100 SH200 | S100 S200 | S100C S200C | H100 H200 | H100C H200C | KD100 KD200/KD300 | KN100 KN200 |
| SNGA120404 | 12.7 | 12.7 | 5.16 | 4.76 | 0.4 | ○ | ○ | ○ | ● | ● | ○ | ● |
| SNGA120408 | 12.7 | 12.7 | 5.16 | 4.76 | 0.8 | ○ | ○ | ○ | ● | ● | ○ | ● |
| SNGA120412 | 12.7 | 12.7 | 5.16 | 4.76 | 1.2 | ○ | ○ | ○ | ● | ● | ○ | ● |



| 型号 Type | 尺寸参数 Dimension (mm) | | | | | 牌号 Grades | | | | | | |
|------------|---------------------|------------|----------|------|-----|----------------|--------------|----------------|--------------|----------------|----------------------|----------------|
| | L | ϕ I.C | ϕ d | S | r | SH100 SH200 | S100 S200 | S100C S200C | H100 H200 | H100C H200C | KD100 KD200/KD300 | KN100 KN200 |
| CNGA120404 | 12.9 | 12.7 | 5.16 | 4.76 | 0.4 | ○ | ○ | ○ | ● | ● | ● | ● |
| CNGA120408 | 12.9 | 12.7 | 5.16 | 4.76 | 0.8 | ○ | ○ | ○ | ● | ● | ● | ● |
| CNGA120412 | 12.9 | 12.7 | 5.16 | 4.76 | 1.2 | ○ | ○ | ○ | ● | ● | ● | ● |
| CNGA120416 | 12.9 | 12.7 | 5.16 | 4.76 | 1.6 | ○ | ○ | ○ | ● | ● | ● | ● |



| 型号 Type | 尺寸参数 Dimension (mm) | | | | | 牌号 Grades | | | | | | |
|------------|---------------------|------------|----------|------|-----|----------------|--------------|----------------|--------------|----------------|----------------------|----------------|
| | L | ϕ I.C | ϕ d | S | r | SH100 SH200 | S100 S200 | S100C S200C | H100 H200 | H100C H200C | KD100 KD200/KD300 | KN100 KN200 |
| TNGA110304 | 11 | 6.35 | 2.3 | 3.18 | 0.4 | ○ | ○ | ○ | ● | ● | ● | ● |
| TNGA110308 | 11 | 6.35 | 2.3 | 3.18 | 0.8 | ○ | ○ | ○ | ● | ● | ● | ● |
| TNGA160404 | 16.5 | 9.525 | 3.8 | 4.76 | 0.4 | ○ | ○ | ○ | ● | ● | ● | ● |
| TNGA160408 | 16.5 | 9.525 | 3.8 | 4.76 | 0.8 | ○ | ○ | ○ | ● | ● | ● | ● |



| 型号 Type | 尺寸参数 Dimension (mm) | | | | | 牌号 Grades | | | | | | |
|------------|---------------------|------------|----------|------|-----|----------------|--------------|----------------|--------------|----------------|----------------------|----------------|
| | L | ϕ I.C | ϕ d | S | r | SH100 SH200 | S100 S200 | S100C S200C | H100 H200 | H100C H200C | KD100 KD200/KD300 | KN100 KN200 |
| WNGA080404 | 8.7 | 12.7 | 5.16 | 4.76 | 0.4 | ○ | ○ | ○ | ● | ● | ● | ● |
| WNGA080408 | 8.7 | 12.7 | 5.16 | 4.76 | 0.8 | ○ | ○ | ○ | ● | ● | ● | ● |
| WNGA080412 | 8.7 | 12.7 | 5.16 | 4.76 | 1.2 | ○ | ○ | ○ | ● | ● | ● | ● |

●表示推荐选择 Priority choice

○表示可选 Optional

备注：刃口形式可根据客户需求定制

Note: Chamfer can be customized.

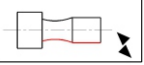
应用 

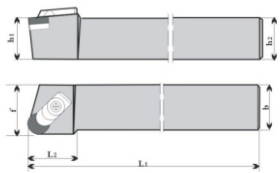

| 型号 (含左右手) Type | 尺寸参数 Dimension | | | | 配套刀片 Matched insert |
|----------------|----------------|----|----|-----|---------------------|
| | h1=h2 | L2 | b | L1 | |
| CRGNR/L2020M09 | 20 | 30 | 20 | 150 | RNMN09 |
| CRGNR/L2525M12 | 25 | 30 | 25 | 150 | RNMN12 |
| CRGNR/L3232P15 | 32 | 35 | 32 | 170 | RNMN15 |
| CRGNR/L4040S20 | 40 | 38 | 40 | 250 | RNMN20 |
| CRGNR/L5050T25 | 50 | 38 | 50 | 300 | RNMN25 |

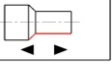
应用 

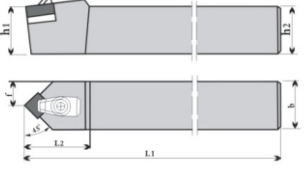

| 型号 (含左右手) Type | 尺寸参数 Dimension | | | | 配套刀片 Matched insert |
|----------------|----------------|----|----|-----|---------------------|
| | h1=h2 | L2 | b | L1 | |
| CSDNN2020M09 | 20 | 30 | 20 | 150 | SNMN09 |
| CSDNN2525M12 | 25 | 30 | 25 | 150 | SNMN12 |
| CSDNN3232P12 | 32 | 35 | 32 | 170 | SNMN12 |
| CSDNN4040S15 | 40 | 38 | 40 | 250 | SNMN15 |
| CSDNN5050T20 | 50 | 38 | 50 | 300 | SNMN20 |

应用 

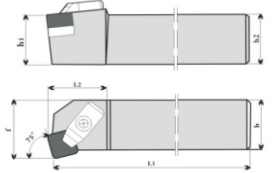

| 型号 (含左右手) Type | 尺寸参数 Dimension | | | | 配套刀片 Matched insert |
|----------------|----------------|----|----|-----|---------------------|
| | h1=h2 | L2 | b | L1 | |
| CSKNR/L2020M09 | 20 | 30 | 20 | 150 | SNMN09 |
| CSKNR/L2525M12 | 25 | 30 | 25 | 150 | SNMN12 |
| CSKNR/L3232P12 | 32 | 35 | 32 | 170 | SNMN12 |
| CSKNR/L4040S15 | 40 | 38 | 40 | 250 | SNMN15 |
| CSKNR/L5050T20 | 50 | 38 | 50 | 300 | SNMN20 |

| 型号 (含左右手) Type | 尺寸参数 Dimension | | | | 配套刀片 Matched insert |
|----------------|----------------|----|----|-----|---------------------|
| | h1=h2 | L2 | b | L1 | |
| CRDCN2020M06 | 20 | 30 | 20 | 150 | RCMX06 |
| CRDCN2525M09 | 25 | 30 | 25 | 150 | RCMX09 |
| CRDCN3232P12 | 32 | 35 | 32 | 170 | RCMX12 |
| CRDCN4040S15 | 40 | 38 | 40 | 250 | RCMX15 |
| CRDCN5050T19 | 50 | 38 | 50 | 300 | RCMX19 |

| 型号 (含左右手) Type | 尺寸参数 Dimension | | | | 配套刀片 Matched insert |
|----------------|----------------|----|----|-----|---------------------|
| | h1=h2 | L2 | b | L1 | |
| CRDCN2020M09 | 20 | 30 | 20 | 150 | RCMN09 |
| CRDCN2525M12 | 25 | 30 | 25 | 150 | RCMN12 |
| CRDCN3232P12 | 32 | 35 | 32 | 170 | RCMN12 |
| CRDCN4040S15 | 40 | 38 | 40 | 250 | RCMN15 |
| CRDCN5050T15 | 50 | 38 | 50 | 300 | RCMN15 |

| 型号 (含左右手) Type | 尺寸参数 Dimension | | | | 配套刀片 Matched insert |
|----------------|----------------|----|----|-----|---------------------|
| | h1=h2 | L2 | b | L1 | |
| CRDNN2020M09 | 20 | 30 | 20 | 150 | RNMN09 |
| CRDNN2525M12 | 25 | 30 | 25 | 150 | RNMN12 |
| CRDNN3232P15 | 32 | 35 | 32 | 170 | RNMN15 |
| CRDNN4040S20 | 40 | 38 | 40 | 250 | RNMN20 |
| CRDNN5050T25 | 50 | 38 | 50 | 300 | RNMN25 |

应用

| 型号 (含左右手) Type | 尺寸参数 Dimension | | | | 配套刀片 Matched insert |
|----------------|----------------|----|----|-----|---------------------|
| | h1=h2 | L2 | b | L1 | |
| CSRNR/L2020M09 | 20 | 30 | 20 | 150 | SNMN09 |
| CSRNR/L2525M12 | 25 | 30 | 25 | 150 | SNMN12 |
| CSRNR/L3232P12 | 32 | 35 | 32 | 170 | SNMN12 |
| CSRNR/L4040S15 | 40 | 38 | 40 | 250 | SNMN15 |
| CSRNR/L5050T20 | 50 | 38 | 50 | 300 | SNMN20 |

应用

| 型号 (含左右手) Type | 尺寸参数 Dimension | | | | 配套刀片 Matched insert |
|----------------|----------------|----|----|-----|---------------------|
| | h1=h2 | L2 | b | L1 | |
| CSXNR/L2020M09 | 20 | 30 | 20 | 150 | SNMN09 |
| CSXNR/L2525M12 | 25 | 30 | 25 | 150 | SNMN12 |
| CSXNR/L3232P12 | 32 | 35 | 32 | 170 | SNMN12 |
| CSXNR/L4040S15 | 40 | 38 | 40 | 250 | SNMN15 |
| CSXNR/L5050T20 | 50 | 38 | 50 | 300 | SNMN20 |

应用

| 型号 (含左右手) Type | 尺寸参数 Dimension | | | | 配套刀片 Matched insert |
|----------------|----------------|----|----|-----|---------------------|
| | h1=h2 | L2 | b | L1 | |
| CSSNR/L2020M09 | 20 | 30 | 20 | 150 | SNMN09 |
| CSSNR/L2525M12 | 25 | 30 | 25 | 150 | SNMN12 |
| CSSNR/L3232P12 | 32 | 35 | 32 | 170 | SNMN12 |
| CSSNR/L4040S15 | 40 | 38 | 40 | 250 | SNMN15 |
| CSSNR/L5050T20 | 50 | 38 | 50 | 300 | SNMN20 |

应用

| 型号 (含左右手) Type | 尺寸参数 Dimension | | | | 配套刀片 Matched insert |
|----------------|----------------|----|----|-----|---------------------|
| | h1=h2 | L2 | b | L1 | |
| CCLNR/L2020M09 | 20 | 30 | 20 | 150 | CNMN09 |
| CCLNR/L2525M12 | 25 | 30 | 25 | 150 | CNMN12 |
| CCLNR/L3232P12 | 32 | 35 | 32 | 170 | CNMN12 |
| CCLNR/L4040S12 | 40 | 38 | 40 | 250 | CNMN12 |
| CCLNR/L5050T12 | 50 | 38 | 50 | 300 | CNMN12 |

应用

| 型号 (含左右手) Type | 尺寸参数 Dimension | | | | 配套刀片 Matched insert |
|----------------|----------------|----|----|-----|---------------------|
| | h1=h2 | L2 | b | L1 | |
| CDLNR/L2020M11 | 20 | 30 | 20 | 150 | DNMN11 |
| CDLNR/L2525M11 | 25 | 30 | 25 | 150 | DNMN11 |
| CDLNR/L3232P11 | 32 | 35 | 32 | 170 | DNMN11 |

应用

| 型号 (含左右手) Type | 尺寸参数 Dimension | | | | 配套刀片 Matched insert |
|----------------|----------------|----|----|-----|---------------------|
| | h1=h2 | L2 | b | L1 | |
| CRDCN2020M06 | 20 | 30 | 20 | 150 | RCMX06 |
| CRDCN2525M09 | 25 | 30 | 25 | 150 | RCMX09 |
| CRDCN3232P12 | 32 | 35 | 32 | 170 | RCMX12 |
| CRDCN4040S15 | 40 | 38 | 40 | 250 | RCMX15 |
| CRDCN5050T20 | 50 | 38 | 50 | 300 | RCMX20 |

内冷方刀杆-通用型

Internally cooled square tool holder - universal type

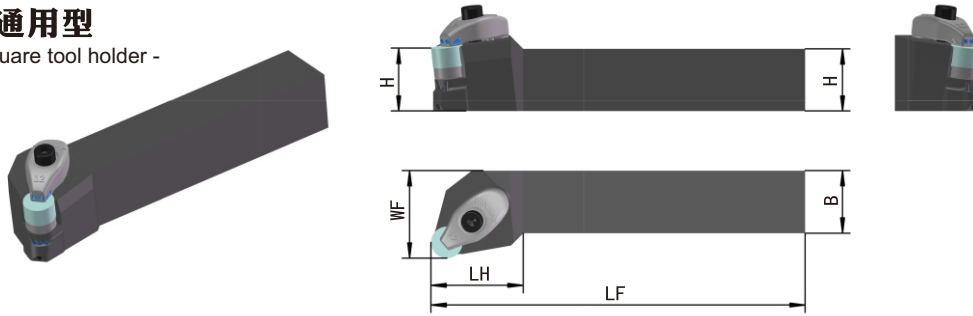

| 应用 application | 型号 type | 尺寸 Dimension (mm) | | | | | |
|-----------------|-----------------|-------------------|-----|-----|----|----|------------|
| | | H | B | LF | LH | WF | |
| | 右手刀-R | | | | | | |
| | CRSNR2525M12-IC | 25 | 25 | 150 | 37 | 35 | RN**1207** |
| | CRSNR2525P12-IC | 25 | 25 | 170 | 37 | 35 | |
| | CRSNR3232P12-IC | 32 | 32 | 170 | 37 | 42 | |
| | CRSNR4040R12-IC | 40 | 40 | 200 | 37 | 50 | |
| | 左手刀-L | | | | | | |
| | CRSNL2525M12-IC | 25 | 25 | 150 | 37 | 35 | RN**1207** |
| | CRSNL2525P12-IC | 25 | 25 | 170 | 37 | 35 | |
| CRSNL3232P12-IC | 32 | 32 | 170 | 37 | 42 | | |
| CRSNL4040R12-IC | 40 | 40 | 200 | 37 | 50 | | |

内冷方刀杆-中置型

Internally cooled square toolholder - central-type

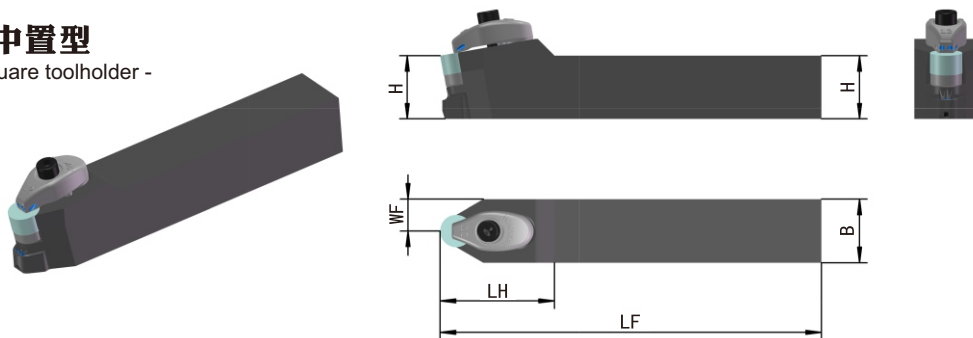

| 应用 appliance | 型号 type | 尺寸 Dimension (mm) | | | | | |
|--------------|-----------------|-------------------|----|-----|----|------|------------|
| | | H | B | LF | LH | WF | |
| | 双向刀-N | | | | | | |
| | CRDNN2525M12-IC | 25 | 25 | 150 | 45 | 12.5 | RN**1207** |
| | CRDNN2525P12-IC | 25 | 25 | 170 | 45 | 12.5 | |
| | CRDNN3232P12-IC | 32 | 32 | 170 | 45 | 16 | |
| | CRDNN4040R12-IC | 40 | 40 | 200 | 45 | 20 | |

内冷Capto刀杆-通用型

Internally cooled Capto tool holder - universal type

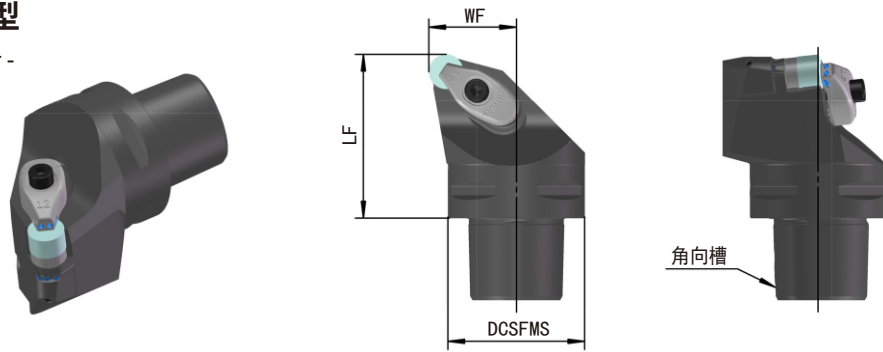

| 应用 application | 型号 type | 尺寸 Dimension (mm) | | | | |
|--------------------|--------------------|-------------------|--------|----|----|------------|
| | | CZCms | DCSFms | LF | LH | |
| | 右手刀-R | | | | | RN**1207** |
| | CRSNR27C4C120CP-IC | C4 | 40 | 27 | 50 | |
| | CRSNR32C5D120CP-IC | C5 | 50 | 32 | 60 | |
| | CRSNR32C6E120CP-IC | C6 | 63 | 39 | 70 | |
| | 左手刀-L | | | | | RN**1207** |
| | CRSNL27C4C120CP-IC | C4 | 40 | 27 | 50 | |
| CRSNL32C5D120CP-IC | C5 | 50 | 32 | 60 | | |
| CRSNL32C6E120CP-IC | C6 | 63 | 39 | 70 | | |

内冷Capto刀杆-中置型

Internally cooled Capto tool holder - central-type

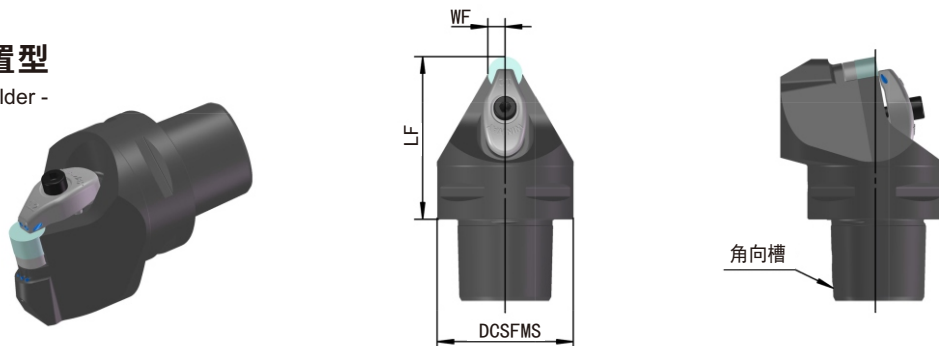

| 应用 application | 型号 type | 尺寸 Dimension (mm) | | | | |
|----------------|--------------------|-------------------|--------|------|----|------------|
| | | CZCms | DCSFms | LF | LH | |
| | 双向刀-N | | | | | RN**1207** |
| | CRDNN06C4C120CP-IC | C4 | 40 | 6.35 | 50 | |
| | CRDNN06C5D120CP-IC | C5 | 50 | 6.35 | 60 | |
| | CRDNN06C6E120CP-IC | C6 | 63 | 6.35 | 70 | |

产品特点

1. 模块化设计，标准的模块化设计可以改变连接长度和工具模块，实现产品或工艺的快速变化。
2. 换刀时间缩短，换刀时间减少10次，有效利用率提高25%。
3. 定位精度高，三角弧设计定位精度高精度和重复定位精度（2 μ）。
4. 自带传动功能，传动稳定，扭矩大，实现大切削。
5. 刀架采用1:20三支短锥度，实现高速进给切削。
6. 接收器内部的水孔具有内部冷却功能，具有良好的冷却效果。
7. 它的应用范围很广，接收器可以做成不同类型的机床接口，可以满足不同制造商的机床安装要求。产品特点

Product feature

1. Modular design, the standard modular design can change the connection length and tool module at will to realize rapid product or process change.
2. The tool change time is shortened, the tool change time is shortened by 10 times, and the effective utilization rate is increased by 25%.
3. High positioning accuracy, the triangular arc design has high positioning accuracy and repeat positioning accuracy (2 μ) .
4. Self-contained transmission function, stable transmission and high torque to achieve heavy cutting.
5. The tool holder adopts a 1:20 three-branch short taper to achieve high-speed feed cutting.
6. The water hole inside the receiver has an internal cooling function, it has a good effect of cooling.
7. It has a wide range of application, the receiver can be made into different types of machine tool interface, which can meet the installation requirements of different manufacturers of machine tools. Product feature

命名规则 Naming rules

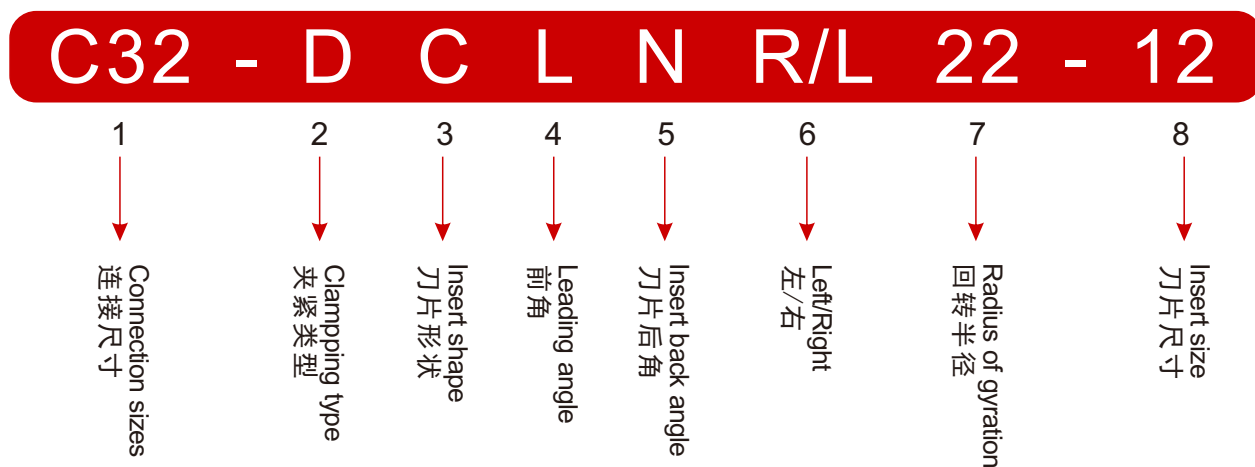

产品特点

1. 快速换刀，尺寸稳定，有效减少换刀和对刀时间
2. 更高的稳定性和加工精度
3. 更方便的内部冷却

Product Features

1. Fast tool change, stable size, effectively reducing tool change and tool setting time
2. Higher stability and machining accuracy;
3. More convenient internal cooling



机床 LATHES



镗床 BORING

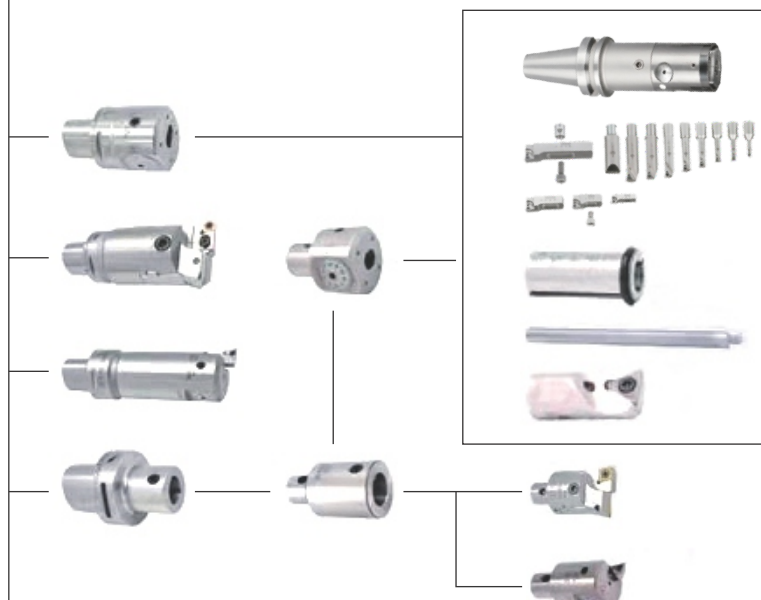

DCLNR/L-Kr95°

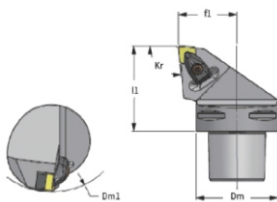

图示显示右手
The illustration shows the right hand

| 编号 Part number | 尺寸 Size | | | 刀片 Inserts | 垫片 Shim | 垫片螺钉 Shim Screw | 压板组件 Platen Assembly | 扳手 Wrench |
|-------------------|---------|----|----|---------------|------------|--------------------|-------------------------|--------------|
| | Dm | f1 | L1 | | | | | |
| C32-DCLNR/L22-12 | 32 | 22 | 45 | CN**1204** | C-MCN43 | C-S4085 | C-CLZ021 | T15 |
| C40-DCLNR/L27-12 | 40 | 27 | 50 | | | | | |
| C50-DCLNR/L35-12 | 50 | 35 | 60 | | | | | |
| C63-DCLNR/L45-12 | 63 | 45 | 65 | | | | | |
| C80-DCLNR/L55-12 | 80 | 55 | 80 | | | | | |
| C40-DCLNR/L27-16 | 40 | 27 | 55 | CN**1606** | C-MCN53 | C-S5011 | C-CLZ031 | T20 |
| C50-DCLNR/L35-16 | 50 | 35 | 60 | | | | | |
| C63-DCLNR/L45-16 | 63 | 45 | 65 | | | | | |
| C80-DCLNR/L55-16 | 80 | 55 | 80 | | | | | |
| C50-DCLNR/L35-19 | 50 | 35 | 60 | CN**1906** | C-MCN63 | C-S5011 | C-CLZ041 | T20 |
| C63-DCLNR/L45-19 | 63 | 45 | 65 | | | | | |
| C80-DCLNR/L55-19 | 80 | 55 | 80 | | | | | |

DCLNR/L-Kr93°
DCLNR/L-Kr107.5°

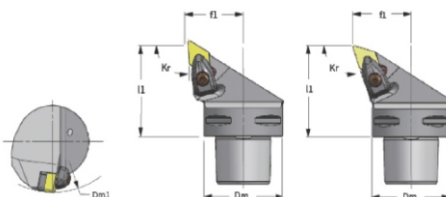

图示显示右手
The illustration shows the right hand

| 编号 Part number | 尺寸 Size | | | 刀片 Inserts | 垫片 Shim | 垫片螺钉 Shim Screw | 压板组件 Platen Assembly | 扳手 Wrench |
|-------------------|---------|----|----|---------------|------------|--------------------|-------------------------|--------------|
| | Dm | f1 | L1 | | | | | |
| C32-DDJNR/L22-11 | 32 | 22 | 45 | DN**1104** | C-MDN32 | C-S3072 | C-CLZ11 | T09 |
| C40-DDJNR/L27-11 | 40 | 27 | 50 | | | | | |
| C50-DDJNR/L35-11 | 50 | 35 | 60 | | | | | |
| C63-DDJNR/L45-11 | 63 | 45 | 65 | | | | | |
| C40-DDJNR/L27-15 | 40 | 27 | 55 | DN**1506** | C-MDN44 | C-S4048 | C-CLZ21 | T15 |
| C50-DDJNR/L35-15 | 50 | 35 | 60 | | | | | |
| C63-DDJNR/L45-15 | 63 | 45 | 65 | | | | | |
| C80-DDJNR/L55-15 | 80 | 55 | 80 | | | | | |
| C40-DDHNR/L27-15 | 40 | 27 | 55 | | | | | |
| C50-DDHNR/L35-15 | 50 | 35 | 60 | | | | | |
| C63-DDHNR/L45-15 | 63 | 45 | 65 | | | | | |
| C80-DDHNR/L55-15 | 80 | 55 | 80 | | | | | |

DSKNR/L-Kr75°
DSDNN-Kr45°
DSSNR/L-Kr45°

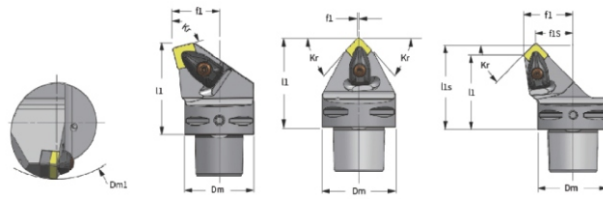

图示显示右手
 The illustration shows the right hand

| 编号 Part number | 尺寸 Size | | | | | 刀片 Inserts | 垫片 Shim | 垫片螺钉 Shim Screw | 压板组件 Platen Assembly | 扳手 Wrench |
|-------------------|---------|-----|----|------|------|---------------|------------|--------------------|-------------------------|--------------|
| | Dm | f1 | L1 | f1s | L1s | | | | | |
| C32-DSKNR/L22-12 | 32 | 22 | 45 | - | - | SN**1204** | C-MSN43 | C-S4085 | C-CLZ21 | T15 |
| C40-DSKNR/L27-12 | 40 | 27 | 50 | - | - | | | | | |
| C50-DSKNR/L35-12 | 50 | 35 | 60 | - | - | | | | | |
| C63-DSKNR/L45-12 | 63 | 45 | 65 | - | - | | | | | |
| C50-DSKNR/L35-19 | 50 | 35 | 60 | - | - | SN**1906** | C-MSN63 | C-S5011 | C-CLZ41 | T20 |
| C63-DSKNR/L45-19 | 63 | 45 | 65 | - | - | | | | | |
| C80-DSKNR/L55-19 | 80 | 55 | 80 | - | - | | | | | |
| C32-DSNDD-12 | 32 | 0.3 | 48 | - | - | SN**1204** | C-MSN43 | C-S4085 | C-CLZ21 | T15 |
| C40-DSNDD-12 | 40 | 0.3 | 50 | - | - | | | | | |
| C50-DSNDD-12 | 50 | 0.3 | 60 | - | - | | | | | |
| C63-DSNDD-12 | 63 | 0.3 | 65 | - | - | | | | | |
| C32-DSSNR/L22-12 | 32 | 22 | 40 | 13.7 | 48.3 | SN**1204** | C-MSN43 | C-S4085 | C-CLZ21 | T15 |
| C40-DSSNR/L27-12 | 40 | 27 | 42 | 18.7 | 50.3 | | | | | |
| C50-DSSNR/L35-12 | 50 | 35 | 52 | 26.7 | 60.3 | | | | | |
| C63-DSSNR/L45-12 | 63 | 45 | 56 | 36.7 | 64.3 | | | | | |

DWLNR/L-Kr95°

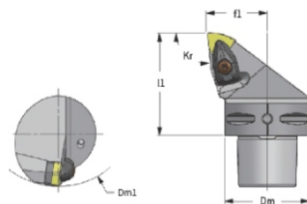

图示显示右手
 The illustration shows the right hand

| 编号 Part number | 尺寸 Size | | | 刀片 Inserts | 垫片 Shim | 垫片螺钉 Shim Screw | 压板组件 Platen Assembly | 扳手 Wrench |
|-------------------|---------|----|----|---------------|------------|--------------------|-------------------------|--------------|
| | Dm | f1 | L1 | | | | | |
| C32-DWLNR/L22-06 | 32 | 22 | 45 | WN**0604** | C-MWN32 | C-S3072 | C-CLZ11 | T09 |
| C40-DWLNR/L27-06 | 40 | 27 | 50 | | | | | |
| C50-DWLNR/L35-06 | 50 | 35 | 60 | | | | | |
| C63-DWLNR/L45-06 | 63 | 45 | 65 | | | | | |
| C40-DWLNR/L27-08 | 40 | 27 | 50 | WN**0804** | C-MWN43 | C-S4085 | C-CLZ21 | T15 |
| C50-DWLNR/L35-08 | 50 | 35 | 60 | | | | | |
| C63-DWLNR/L45-08 | 63 | 45 | 65 | | | | | |
| C80-DWLNR/L55-08 | 80 | 55 | 80 | | | | | |

DVJNR/L-Kr93°

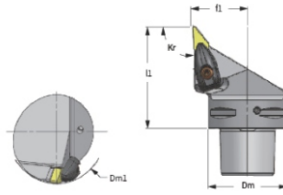

图示显示右手
The illustration shows the right hand

| 编号 Part number | 尺寸 Size | | | 刀片 Inserts | 垫片 Shim | 垫片螺钉 Shim Screw | 压板组件 Platen Assembly | 扳手 Wrench |
|-------------------|---------|----|----|---------------|------------|--------------------|-------------------------|--------------|
| | Dm | f1 | L1 | | | | | |
| C40-DVJNR/L27-16 | 40 | 27 | 62 | VN**1604** | C-MVN32 | C-S3581 | C-CLZ61 | T15 |
| C50-DVJNR/L35-16 | 50 | 35 | 65 | | | | | |
| C63-DVJNR/L45-16 | 63 | 45 | 65 | | | | | |
| C80-DVJNR/L55-16 | 80 | 55 | 80 | | | | | |

PCLNR/L-Kr95°

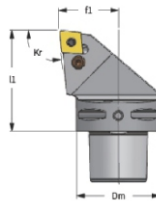

图示显示右手
The illustration shows the right hand

| 编号 Part number | 尺寸 Size | | | 刀片 Inserts | 垫片 Shim | 垫片螺钉 Shim Screw | 钩杆 Cank Hook | 扳手 Wrench |
|-------------------|---------|----|----|---------------|------------|--------------------|-----------------|--------------|
| | Dm | f1 | L1 | | | | | |
| C40-PCLNR/L27-12 | 40 | 27 | 55 | CN**1604** | C-MCN43 | C-TS21 | C-LE41 | L3.0 |
| C50-PCLNR/L35-12 | 50 | 35 | 60 | | | | | |
| C63-PCLNR/L45-12 | 63 | 45 | 65 | | | | | |

PDJNR/L-Kr93°

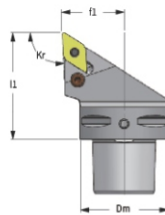

图示显示右手
The illustration shows the right hand

| 编号 Part number | 尺寸 Size | | | 刀片 Inserts | 垫片 Shim | 螺钉 Screw | 钩杆 Cank Hook | 扳手 Wrench |
|-------------------|---------|----|----|---------------|------------|-------------|-----------------|--------------|
| | Dm | f1 | L1 | | | | | |
| C40-PDJNR/L27-15 | 40 | 27 | 55 | DN**1506** | C-MDN43 | C-TS30 | C-LE47 | L3.0 |
| C50-PDJNR/L35-15 | 50 | 35 | 60 | | | | | |
| C63-PDJNR/L45-15 | 63 | 45 | 65 | | | | | |

SDJCR/L-Kr93°

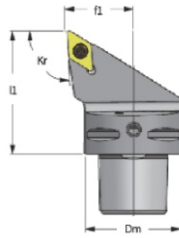

图示显示右手
The illustration shows the right hand

| 编号 Part number | 尺寸 Size | | | 刀片 Inserts | 刀片螺钉 Inserts Screw | 垫片 Shim | 垫片螺钉 Shim Screw | 扳手 Wrench |
|-------------------|---------|----|----|---------------|-----------------------|------------|--------------------|--------------|
| | Dm | f1 | L1 | | | | | |
| C32-SDJCR/L22-11 | 32 | 22 | 40 | DC**11T3** | C-S3512 | C-MDC32 | C-CS0901 | T15 |
| C40-SDJCR/L27-11 | 40 | 27 | 55 | | | | | |
| C50-SDJCR/L35-11 | 50 | 35 | 60 | | | | | |
| C63-SDJCR/L45-11 | 63 | 45 | 65 | | | | | |

**SRDCN
SRSCR/L**

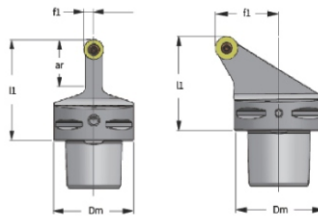

图示显示右手
The illustration shows the right hand

| 编号 Part number | 尺寸 Size | | | | 刀片 Inserts | 刀片螺钉 Inserts Screw | 垫片 Shim | 垫片螺钉 Shim Screw | 扳手 Wrench |
|-------------------|---------|----|----|----|---------------|-----------------------|------------|--------------------|--------------|
| | Dm | ar | f1 | L1 | | | | | |
| C32-SRDCN-10 | 32 | 20 | 5 | 40 | RC**10T3** | C-S3510 | C-MRC01 | C-CS0901 | T15 |
| C40-SRDCN-10 | 40 | 25 | 5 | 55 | | | | | |
| C50-SRDCN-10 | 50 | 25 | 5 | 60 | | | | | |
| C63-SRDCN-10 | 63 | 25 | 5 | 65 | | | | | |
| C50-SRSCR35-16 | 50 | - | 35 | 60 | RC**1606** | C-S5017 | C-MRC03 | C-CS0906 | T20 |
| C63-SRSCR45-16 | 63 | - | 45 | 65 | | | | | |

DCLNR/L-Kr95°

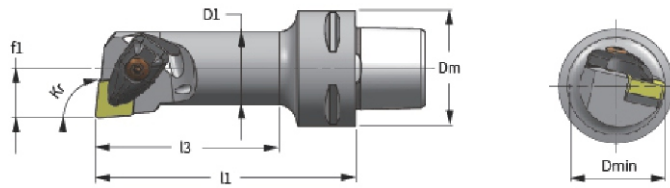

图示显示右手
The illustration shows the right hand

| 编号 Part number | 尺寸 Size | | | | | | 刀片 Inserts | 垫片 Shim | 垫片螺钉 Shim Screw | 压板组件 Platen Assembly | 扳手 Wrench |
|-------------------|---------|------|----|----|-----|----|---------------|------------|--------------------|-------------------------|--------------|
| | Dm | Dmin | D1 | f1 | L1 | L1 | | | | | |
| C40-DCLNR/L32-1 | 40 | 32 | 25 | 17 | 90 | 69 | CN**1204** | C-MCN43 | C-S4085 | C-CLZ21 | T15 |
| C50-DCLNR/L32-1 | 50 | 32 | 25 | 17 | 90 | 69 | | | | | |
| C63-DCLNR/L32-1 | 63 | 32 | 25 | 17 | 100 | 73 | | | | | |

DWLNLR/L-Kr95°

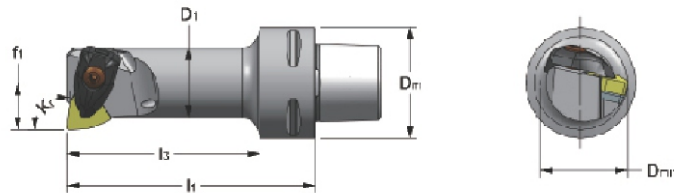

图示显示右手
The illustration shows the right hand

| 编号 Part number | 尺寸 Size | | | | | | 刀片 Inserts | 垫片 Shim | 垫片螺钉 Shim Screw | 压板组件 Platen Assembly | 扳手 Wrench |
|-------------------|---------|------|----|----|----|----|---------------|------------|--------------------|-------------------------|--------------|
| | Dm | Dmin | D1 | f1 | L1 | L1 | | | | | |
| C40-DWLNLR/L32-08 | 40 | 32 | 25 | 17 | 90 | 69 | WN**0804** | C-MWN43 | C-S4085 | C-CLZ21 | T15 |
| C50-DWLNLR/L32-08 | 50 | 32 | 25 | 17 | 90 | 69 | | | | | |

PCLNR/L-Kr95°

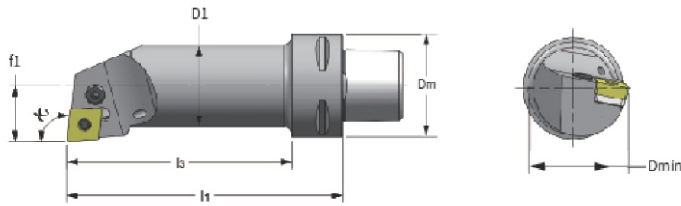

图示显示右手
The illustration shows the right hand

| 编号 Part number | 尺寸 Size | | | | | | 刀片 Inserts | 垫片 Shim | 垫片螺钉 Shim Screw | 钩杆 Cank Hook | 扳手 Wrench |
|-------------------|---------|------|----|----|-----|-----|---------------|------------|--------------------|------------------|--------------|
| | Dm | Dmin | D1 | f1 | L1 | L3 | | | | | |
| C32-PCLNR/L32-12 | 32 | 32 | 25 | 17 | 90 | 75 | CN**1204** | C-MCN43 | C-TS21 C-TS32 | C-LE40 C-LE41 | L2.5 L3.0 |
| C32-PCLNR/L40-12 | 32 | 40 | 32 | 22 | 64 | 50 | | | | | |
| C32-PCLNR/L40-12 | 32 | 40 | 32 | 22 | 96 | 82 | | | | | |
| C40-PCLNR/L32-12 | 40 | 32 | 25 | 17 | 90 | 69 | | | | | |
| C40-PCLNR/L40-12 | 40 | 40 | 32 | 22 | 110 | 89 | | | | | |
| C40-PCLNR/L50-12 | 40 | 50 | 40 | 27 | 80 | 60 | | | | | |
| C40-PCLNR/L50-12 | 40 | 50 | 40 | 27 | 120 | 100 | | | | | |
| C50-PCLNR/L32-12 | 50 | 32 | 25 | 17 | 90 | 67 | | | | | |
| C50-PCLNR/L40-12 | 50 | 40 | 32 | 22 | 110 | 88 | | | | | |
| C50-PCLNR/L50-12 | 50 | 50 | 40 | 27 | 140 | 119 | | | | | |
| C50-PCLNR/L63-12 | 50 | 63 | 50 | 35 | 100 | 81 | | | | | |
| C63-PCLNR/L32-12 | 63 | 32 | 25 | 17 | 100 | 74 | | | | | |
| C63-PCLNR/L40-12 | 63 | 40 | 32 | 22 | 110 | 84 | | | | | |

SDUCR/L-Kr93°

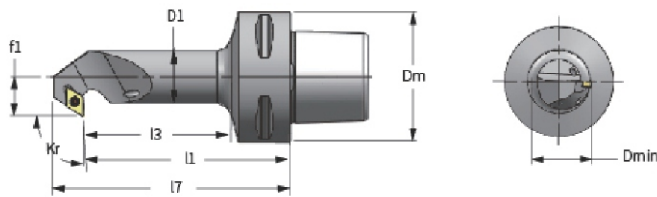

图示显示右手
The illustration shows the right hand

| 编号 Part number | 尺寸 Size | | | | | | | 刀片 Inserts | 刀片螺钉 Inserts Screw | 垫片 Shim | 压板组件 Platen Assembly | 扳手 Wrench |
|-------------------|---------|------|----|----|----|----|-------|---------------|-----------------------|------------|-------------------------|--------------|
| | Dm | Dmin | D1 | f1 | L1 | L3 | L7 | | | | | |
| C32-SDUCR/L22-07 | 32 | 22 | 16 | 13 | 70 | 54 | 80.7 | DC*0702** | C-S2565 | - | - | T07 |
| C32-SDUCR/L27-07 | 32 | 27 | 20 | 15 | 80 | 64 | 80.7 | | | | | |
| C40-SDUCR/L22-07 | 40 | 22 | 16 | 13 | 70 | 48 | 80.7 | | | | | |
| C40-SDUCR/L27-07 | 40 | 27 | 20 | 15 | 80 | 58 | 91.5 | | | | | |
| C40-SDUCR/L32-07 | 40 | 32 | 25 | 18 | 90 | 69 | 101.5 | | | | | |
| C50-SDUCR/L27-07 | 50 | 27 | 20 | 15 | 80 | 58 | 91.5 | | | | | |
| C50-SDUCR/L32-07 | 50 | 32 | 25 | 18 | 90 | 68 | 101.5 | | | | | |

BCBN
External turning, facing
外圆, 端面加工

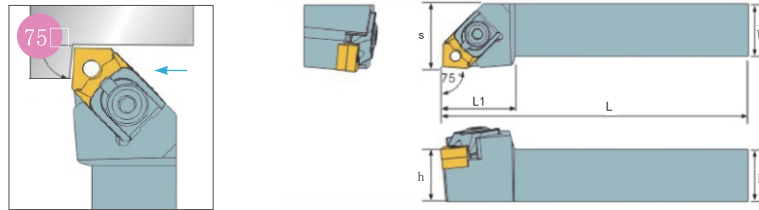

右手刀
right-hand tool

| 编号 Part number | 尺寸 Size | | | | | | 刀片 Inserts | 垫片 Shim | 销钉 Pin | 压板 Platen | 螺钉 Screw | 塞环 Slopperring | 扳手 Wrench |
|-------------------|---------|----|----|-----|----|----|---------------|------------|-----------|--------------|-------------|-------------------|--------------|
| | H | h | W | L | L1 | s | | | | | | | |
| BCBNR/L2525M12 | 25 | 25 | 25 | 150 | 34 | 26 | CN**1204** | MC43 | B-CTP6S | B-CLC12-100 | B-LS08 | B-RP07 | HL3,HL4 |

BCKN
External turning, facing
外圆, 端面加工

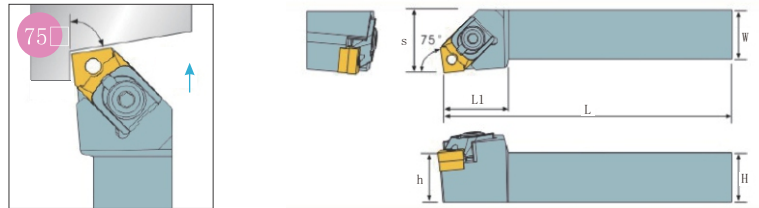

右手刀
right-hand tool

| 编号 Part number | 尺寸 Size | | | | | | 刀片 Inserts | 垫片 Shim | 销钉 Pin | 压板 Platen | 螺钉 Screw | 塞环 Slopperring | 扳手 Wrench |
|-------------------|---------|----|----|-----|----|----|---------------|------------|-----------|--------------|-------------|-------------------|--------------|
| | H | h | W | L | L1 | s | | | | | | | |
| BCKNR/L2525M12 | 25 | 25 | 25 | 150 | 32 | 32 | CN**1204** | MC43 | B-CTP6S | B-CLC12-100 | B-LS08 | B-RP07 | HL3,HL4 |
| BCKNR2525M12-100 | 25 | 25 | 25 | 150 | 32 | 32 | | | | | | | |
| BCKNR/L3232P12 | 32 | 32 | 32 | 170 | 32 | 40 | | | | | | | |

BCLN
External turning, facing
外圆, 端面加工

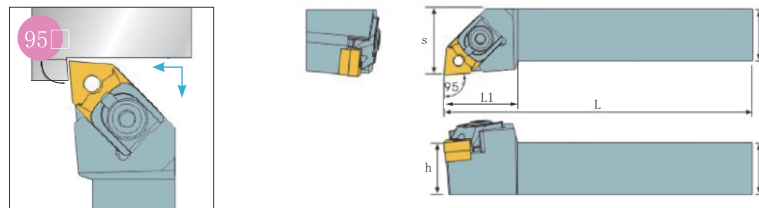

右手刀
right-hand tool

| 编号 Part number | 尺寸 Size | | | | | | 刀片 Inserts | 垫片 Shim | 销钉 Pin | 压板 Platen | 螺钉 Screw | 塞环 Slopperring | 扳手 Wrench |
|-------------------|---------|----|----|-----|----|----|---------------|------------|-----------|--------------|-------------|-------------------|--------------|
| | H | h | W | L | L1 | s | | | | | | | |
| BCLNR/L2020K12 | 20 | 20 | 20 | 125 | 32 | 25 | CN**1204** | MC43 | B-CTP6S | B-CLC12 | B-LS08 | B-RP07 | HL3,HL4 |
| BCLNR/L2525M12 | 25 | 25 | 25 | 150 | 37 | 32 | | | | | | | |
| BCLNR/L3232P12 | 32 | 32 | 32 | 170 | 36 | 40 | | | | | | | |
| BCLNR/L3232P16 | 32 | 32 | 32 | 170 | 38 | 40 | CN**1606** | MC53 | B-CTP8S | B-CLC12 | B-LS08 | B-RP07 | HL3,HL4 |

BCMNN
External turning, facing
外圆, 端面加工

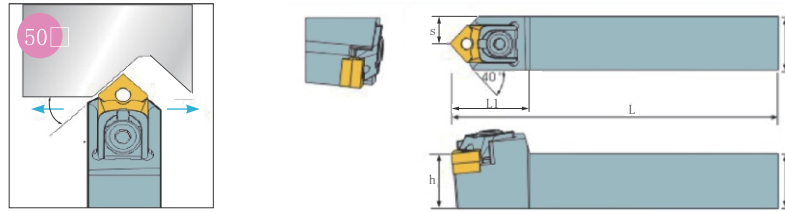

| 编号 Part number | 尺寸 Size | | | | | | 刀片 Inserts | 垫片 Shim | 销钉 Pin | 压板 Platen | 螺钉 Screw | 塞环 Slopperring | 扳手 Wrench |
|-------------------|---------|----|----|-----|----|----|---------------|------------|-----------|--------------|-------------|-------------------|--------------|
| | H | h | W | L | L1 | s | | | | | | | |
| BCMNN2020K12 | 20 | 20 | 20 | 125 | 42 | 10 | CN**1204** | MC43 | B-CTP6S | B-CLC12-100 | B-LS08 | B-RP07 | HL3,HL4 |
| BCMNN3232P12 | 32 | 32 | 32 | 170 | 42 | 16 | | | | | | | |

BCMNN-100
External turning, facing
外圆, 端面加工

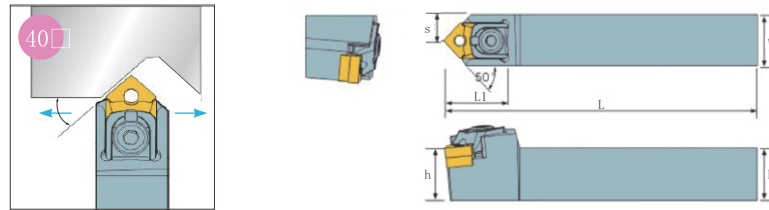

| 编号 Part number | 尺寸 Size | | | | | | 刀片 Inserts | 垫片 Shim | 销钉 Pin | 压板 Platen | 螺钉 Screw | 塞环 Slopperring | 扳手 Wrench |
|-------------------|---------|----|----|-----|----|------|---------------|------------|-----------|--------------|-------------|-------------------|--------------|
| | H | h | W | L | L1 | s | | | | | | | |
| BCMNN2020K12-100 | 20 | 20 | 20 | 125 | 40 | 10 | CN**1204** | MC43 | B-CTP6S | B-CLC12-100 | B-LS08 | B-RP07 | HL3,HL4 |
| BCMNN2525M12-100 | 25 | 25 | 25 | 150 | 40 | 12.5 | | | | | | | |
| BCMNN3232P12-100 | 32 | 32 | 32 | 170 | 40 | 16 | | | | | | | |

BDJNR
External turning, facing
外圆, 端面加工

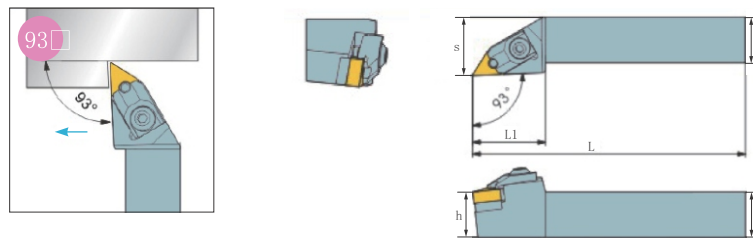

右手刀
right-hand tool

| 编号 Part number | 尺寸 Size | | | | | | 刀片 Inserts | 垫片 Shim | 销钉 Pin | 压板 Platen | 螺钉 Screw | 塞环 Slopperring | 扳手 Wrench |
|-------------------|---------|----|----|-----|----|----|--------------------------|--------------|-----------|--------------|-------------|-------------------|--------------|
| | H | h | W | L | L1 | s | | | | | | | |
| BDJNR/L1616H11 | 16 | 16 | 16 | 100 | 32 | 20 | DN**1104** | MD32 | B-CTP5S | B-CLD11 | B-LS06 | B-RP05 | HL2.5,HL3 |
| BDJNR/L2020K11 | 20 | 20 | 20 | 125 | 32 | 25 | | | | | | | |
| BDJNR/L2525M11 | 25 | 25 | 25 | 150 | 32 | 32 | | | | | | | |
| BDJNR/L2020K1504 | 20 | 20 | 20 | 125 | 46 | 26 | DN**1504** DN**1506** | MD44 MD43 | B-CTP6L | B-CLD15 | B-LS08 | B-RP05 | HL3,HL4 |
| BDJNR/L2020K1506 | 20 | 20 | 20 | 125 | 46 | 26 | | | | | | | |
| BDJNR/L2525M1504 | 25 | 25 | 25 | 150 | 46 | 32 | | | | | | | |
| BDJNR/L2525M1506 | 25 | 25 | 25 | 150 | 46 | 32 | | | | | | | |
| BDJNR/L3232P1504 | 32 | 32 | 32 | 170 | 46 | 40 | | | | | | | |
| BDJNR3232P1506 | 32 | 32 | 32 | 170 | 46 | 40 | | | | | | | |

BDPN
External turning, facing
外圆, 端面加工

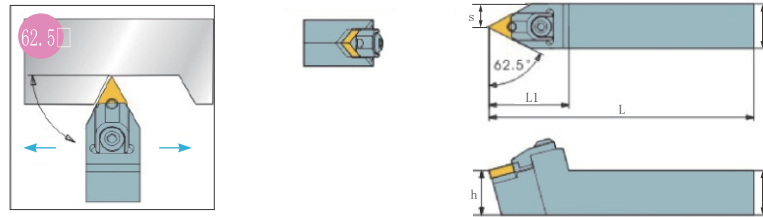

| 编号 Part number | 尺寸 Size | | | | | | 刀片 Inserts | 垫片 Shim | 销钉 Pin | 压板 Platen | 螺钉 Screw | 塞环 Slopperring | 扳手 Wrench |
|-------------------|---------|----|----|-----|----|----|---------------|------------|-----------|--------------|-------------|-------------------|--------------|
| | H | h | W | L | L1 | s | | | | | | | |
| BDPNN2020K1506 | 20 | 20 | 20 | 125 | 50 | 10 | DN**1504** | MD44 | B-CTP6L | B-CLD15 | B-LS08 | B-RP07 | HL3,HL4 |

BSDN
External turning, facing
外圆, 端面加工

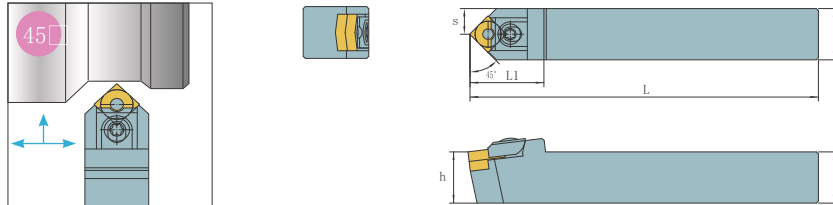

| 编号 Part number | 尺寸 Size | | | | | | 刀片 Inserts | 垫片 Shim | 销钉 Pin | 压板 Platen | 螺钉 Screw | 塞环 Slopperring | 扳手 Wrench |
|-------------------|---------|----|----|-----|----|------|---------------|------------|-----------|--------------|-------------|-------------------|--------------|
| | H | h | W | L | L1 | s | | | | | | | |
| BSDNN2020K12 | 20 | 20 | 20 | 125 | 40 | 10 | SN**1204** | MS43 | B-CTP6S | B-CLS12 | B-LS08 | B-RP07 | HL3,HL4 |
| BSDNN2525M12 | 25 | 25 | 25 | 150 | 40 | 12.5 | | | | | | | |

BTEN
External turning, facing
外圆, 端面加工

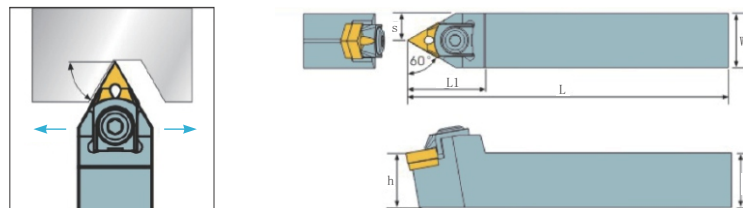

| 编号 Part number | 尺寸 Size | | | | | | 刀片 Inserts | 垫片 Shim | 销钉 Pin | 压板 Platen | 螺钉 Screw | 塞环 Slopperring | 扳手 Wrench |
|-------------------|---------|----|----|-----|----|------|---------------|------------|-----------|--------------|-------------|-------------------|--------------|
| | H | h | W | L | L1 | s | | | | | | | |
| BTENN2020K16 | 20 | 20 | 20 | 125 | 40 | 10 | TN**1604** | MS32 | B-CTP5S | B-CLT16 | B-LS08 | B-RP07 | HL2.5,HL4 |
| BTENN2525M16 | 25 | 25 | 25 | 150 | 40 | 12.5 | | | | | | | |

BTGN
External turning, facing
外圆, 端面加工

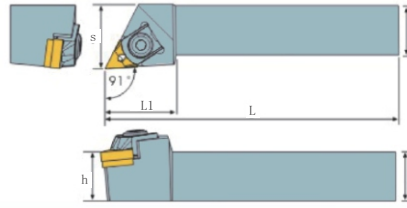
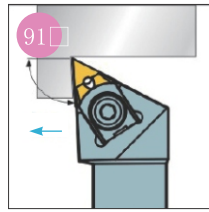

右手刀
right-hand tool

| 编号 Part number | 尺寸 Size | | | | | | 刀片 Inserts | 垫片 Shim | 销钉 Pin | 压板 Platen | 螺钉 Screw | 塞环 Stopperring | 扳手 Wrench |
|-------------------|---------|----|----|-----|----|------|---------------|------------|-----------|--------------|-------------|-------------------|--------------|
| | H | h | W | L | L1 | s | | | | | | | |
| BTGNL1616H16 | 16 | 16 | 16 | 100 | 30 | 20.5 | TN**1604** | MT32 | B-CTP5S | B-CLT16-N | B-LS06 | B-RP07 | HL2. 5,HL3 |
| BTGNL2020K16 | 20 | 20 | 20 | 125 | 35 | 25 | TN**1604** | MT32 | B-CTP5S | B-CLT16 | B-LS08 | B-RP07 | HL2. 5,HL4 |
| BTGNL/R2525M16 | 25 | 25 | 25 | 150 | 35 | 32 | | | | | | | |
| BTGNL/R3232P16 | 32 | 32 | 32 | 170 | 35 | 40 | | | | | | | |

BTJN
External turning, facing
外圆, 端面加工

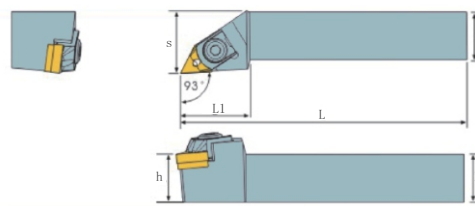
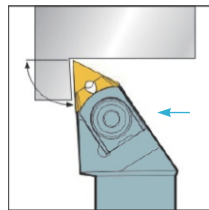

右手刀
right-hand tool

| 编号 Part number | 尺寸 Size | | | | | | 刀片 Inserts | 垫片 Shim | 销钉 Pin | 压板 Platen | 螺钉 Screw | 塞环 Stopperring | 扳手 Wrench |
|-------------------|---------|----|----|-----|----|----|---------------|------------|-----------|--------------|-------------|-------------------|--------------|
| | H | h | W | L | L1 | s | | | | | | | |
| BTJNR/L1616H16 | 16 | 16 | 16 | 100 | 30 | 20 | TN**1604** | MT32 | B-CTP5S | B-CLT16-N | B-LS06 | B-RP07 | HL2. 5,HL3 |
| BTJNR/L2020K16 | 20 | 20 | 20 | 125 | 35 | 25 | TN**1604** | MT32 | B-CTP5S | B-CLT16 | B-LS08 | B-RP07 | HL2. 5,HL4 |
| BTJNR/L2525M16 | 25 | 25 | 25 | 150 | 35 | 32 | | | | | | | |
| BTJNR/L3232P16 | 32 | 32 | 32 | 170 | 35 | 40 | | | | | | | |

BTQN
External turning, facing
外圆, 端面加工

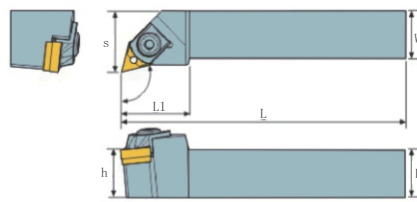
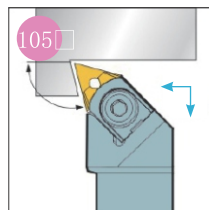

右手刀
right-hand tool

| 编号 Part number | 尺寸 Size | | | | | | 刀片 Inserts | 垫片 Shim | 销钉 Pin | 压板 Platen | 螺钉 Screw | 塞环 Stopperring | 扳手 Wrench |
|-------------------|---------|----|----|-----|----|----|---------------|------------|-----------|--------------|-------------|-------------------|--------------|
| | H | h | W | L | L1 | s | | | | | | | |
| BTQNR/L2020K16 | 20 | 20 | 20 | 125 | 35 | 25 | TN**1604** | MT32 | B-CTP5S | B-CLT16 | B-LS08 | B-RP07 | HL2. 5,HL4 |
| BTQNR2525M16 | 25 | 25 | 25 | 150 | 35 | 32 | | | | | | | |
| BTQNR/L3232P16 | 32 | 32 | 32 | 170 | 35 | 40 | | | | | | | |

BWLN
External turning, facing
外圆, 端面加工

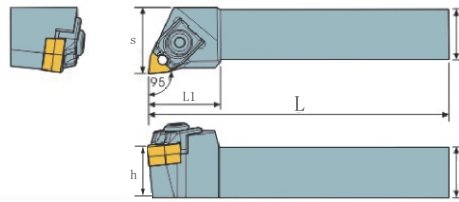
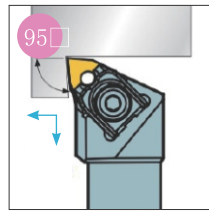

右手刀
right-hand tool

| 编号 Part number | 尺寸 Size | | | | | | 刀片 Inserts | 垫片 Shim | 销钉 Pin | 压板 Platen | 螺钉 Screw | 塞环 Stopperring | 扳手 Wrench |
|-------------------|---------|----|----|-----|----|----|---------------|------------|-----------|--------------|-------------|-------------------|--------------|
| | H | h | W | L | L1 | s | | | | | | | |
| BWLN/L1616H06 | 16 | 16 | 16 | 100 | 27 | 20 | WN**0604** | MW32 | B-CTP5S | B-CLW06 | B-LS06 | B-RP05 | HL2,5,HL3 |
| BWLN/L2020K06 | 20 | 20 | 20 | 125 | 27 | 25 | | | | | | | |
| BWLN/L2525M16 | 25 | 25 | 25 | 150 | 27 | 32 | | | | | | | |
| BWLN/L2020K08 | 20 | 20 | 20 | 125 | 32 | 25 | WN**0804** | MW43 | B-CTP6S | B-CLW08 | B-LS08 | B-RP07 | HL3,HL4 |
| BWLN/L2525M08 | 25 | 25 | 25 | 150 | 32 | 32 | | | | | | | |
| BWLN/L3232P08 | 32 | 32 | 32 | 170 | 32 | 40 | | | | | | | |

DCBN

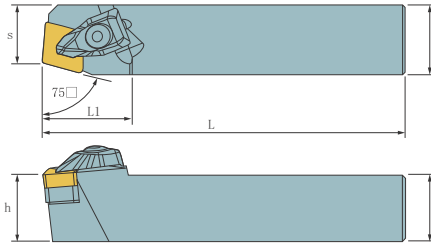
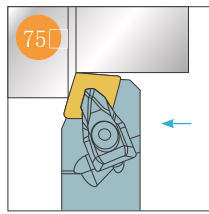

右手刀
right-hand tool

| 编号 Part number | 尺寸 Size | | | | | | 刀片 Inserts | 垫片 Shim | 销钉 Pin | 压板 Platen | 螺钉 Screw | 塞环 Slopperring | 扳手 Wrench |
|-------------------|---------|----|----|-----|----|----|---------------|------------|-----------|--------------|-------------|-------------------|--------------|
| | H | h | W | L | L1 | s | | | | | | | |
| DCBNR2020K12 | 20 | 20 | 20 | 125 | 31 | 17 | CN**1204** | MC43 | S5012T | D-CLM4 | D-LS4 | D-SP4 | HL3,TIP20 |
| DCBNR/L2525M12 | 25 | 25 | 25 | 150 | 32 | 22 | | | | | | | |

DCKN

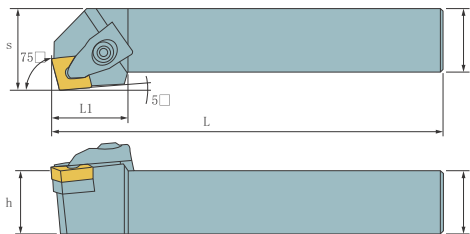
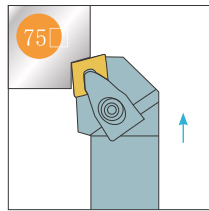

右手刀
right-hand tool

| 编号 Part number | 尺寸 Size | | | | | | 刀片 Inserts | 垫片 Shim | 销钉 Pin | 压板 Platen | 螺钉 Screw | 塞环 Slopperring | 扳手 Wrench |
|-------------------|---------|----|----|-----|----|----|---------------|------------|-----------|--------------|-------------|-------------------|--------------|
| | H | h | W | L | L1 | s | | | | | | | |
| DCKNL2020K12 | 20 | 20 | 20 | 125 | 29 | 25 | CN**1204** | MC43 | S5012T | D-CLM4 | D-LS4 | D-SP4 | HL3,TIP20 |
| DCKNL2525M12 | 25 | 25 | 25 | 150 | 29 | 32 | | | | | | | |

DCLN

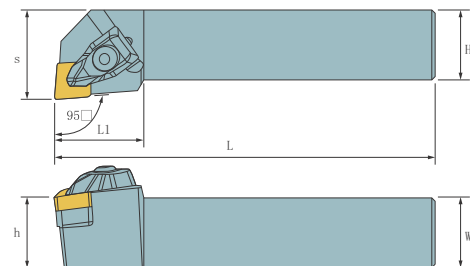
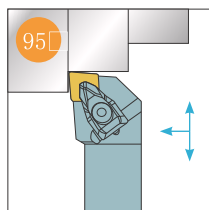

right-hand tool

| 编号 Part number | 尺寸 Size | | | | | | 刀片 Inserts | 垫片 Shim | 销钉 Pin | 压板 Platen | 螺钉 Screw | 塞环 Slopperring | 扳手 Wrench |
|-------------------|---------|----|----|-----|----|----|---------------|------------|-----------|--------------|-------------|-------------------|--------------|
| | H | h | W | L | L1 | s | | | | | | | |
| DCLNR/L2020K12 | 20 | 20 | 20 | 125 | 30 | 25 | CN**1204** | MC43 | S5012T | D-CLM4 | D-LS4 | D-SP4 | HL3,TIP20 |
| DCLNR/L2525M12 | 25 | 25 | 25 | 150 | 30 | 32 | | | | | | | |

DCMNN

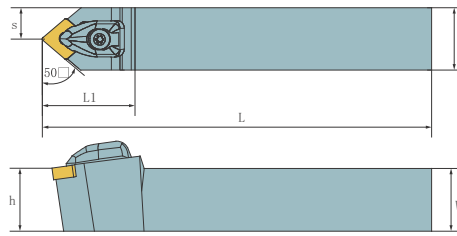
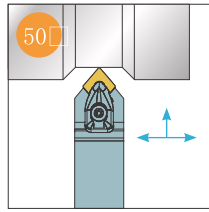

右手刀
right-hand tool

| 编号 Part number | 尺寸 Size | | | | | | 刀片 Inserts | 垫片 Shim | 销钉 Pin | 压板 Platen | 螺钉 Screw | 塞环 Stopperring | 扳手 Wrench |
|-------------------|---------|----|----|-----|----|------|---------------|------------|-----------|--------------|-------------|-------------------|--------------|
| | H | h | W | L | L1 | s | | | | | | | |
| DCMNN2020K12 | 20 | 20 | 20 | 125 | 34 | 10 | CN**1204** | MC43 | S5012T | D-CLM4 | D-LS4 | D-SP4 | HL3,TIP20 |
| DCMNN2525M12 | 25 | 25 | 25 | 150 | 34 | 12.5 | | | | | | | |

DDJN

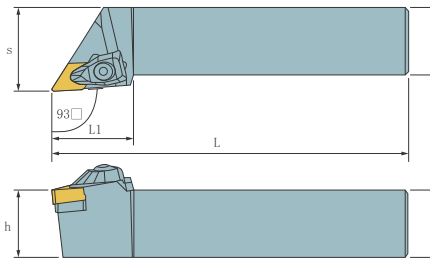
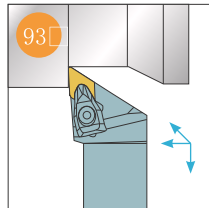

右手刀
right-hand tool

| 编号 Part number | 尺寸 Size | | | | | | 刀片 Inserts | 垫片 Shim | 销钉 Pin | 压板 Platen | 螺钉 Screw | 塞环 Stopperring | 扳手 Wrench |
|-------------------|---------|----|----|-----|----|----|---------------|------------|-----------|--------------|-------------|-------------------|--------------|
| | H | h | W | L | L1 | s | | | | | | | |
| DDJNL2020K11 | 20 | 20 | 20 | 125 | 30 | 25 | DN**1104** | MD32 | S4012T | D-CLM3 | D-LS3 | D-SP3 | HL2.5,HL3 |
| DDJNR/L2525M11 | 25 | 25 | 25 | 150 | 30 | 32 | | | | | | | |
| DDJNR/L2020K1504 | 20 | 20 | 20 | 125 | 39 | 25 | DN**1504** | MD44 | S5012T | D-CLM4 | D-LS4 | D-SP4 | HL3,TIP20 |
| DDJNR/L2525K1504 | 25 | 25 | 25 | 150 | 39 | 32 | | | | | | | |
| DDJNR/L2020K1506 | 20 | 20 | 20 | 125 | 39 | 25 | DN**1506** | MD43 | S5012T | D-CLM4 | D-LS4 | D-SP4 | HL3,TIP20 |
| DDJNR/L2525M1506 | 25 | 25 | 25 | 150 | 39 | 32 | | | | | | | |

DDPNN

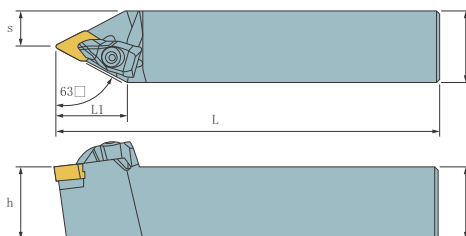
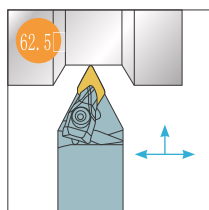

| 编号 Part number | 尺寸 Size | | | | | | 刀片 Inserts | 垫片 Shim | 销钉 Pin | 压板 Platen | 螺钉 Screw | 塞环 Stopperring | 扳手 Wrench |
|-------------------|---------|----|----|-----|----|------|---------------|------------|-----------|--------------|-------------|-------------------|--------------|
| | H | h | W | L | L1 | s | | | | | | | |
| DDPNN2525M1506 | 25 | 25 | 25 | 150 | 38 | 12.5 | DN**1506** | MD43 | S5012T | D-CLM4 | D-LS4 | D-SP4 | HL3,TIP20 |

DSDNN

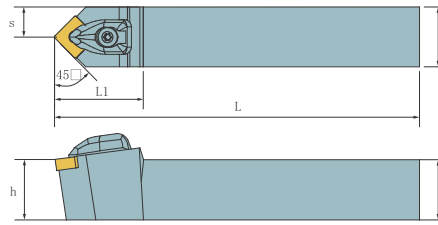
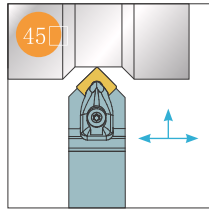

| 编号 Part number | 尺寸 Size | | | | | | 刀片 Inserts | 垫片 Shim | 销钉 Pin | 压板 Platen | 螺钉 Screw | 弹簧 Spring | 扳手 Wrench |
|-------------------|---------|----|----|-----|----|------|---------------|------------|-----------|--------------|-------------|--------------|--------------|
| | H | h | W | L | L1 | s | | | | | | | |
| DSDNN2020K12 | 20 | 20 | 20 | 125 | 34 | 10 | SN**1204** | MS43 | S5012T | D-CLM4 | D-LS4 | D-SP4 | HL3,TIP20 |
| DSDNN2525M12 | 25 | 25 | 25 | 150 | 34 | 12.5 | | | | | | | |

DSKN

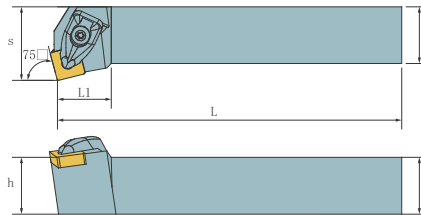
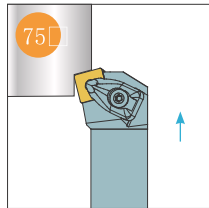

右手刀
right-hand tool

| 编号 Part number | 尺寸 Size | | | | | | 刀片 Inserts | 垫片 Shim | 销钉 Pin | 压板 Platen | 螺钉 Screw | 弹簧 Spring | 扳手 Wrench |
|-------------------|---------|----|----|-----|----|----|---------------|------------|-----------|--------------|-------------|--------------|--------------|
| | H | h | W | L | L1 | s | | | | | | | |
| DSKNL2525M12 | 25 | 25 | 25 | 150 | 29 | 32 | SN**1204** | MS43 | S5012T | D-CLM4 | D-LS4 | D-SP4 | HL3,TIP20 |

DSSN

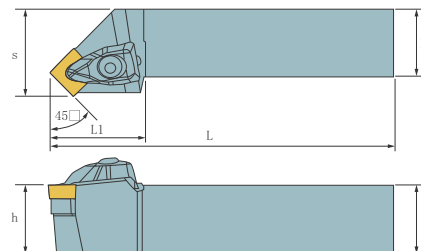
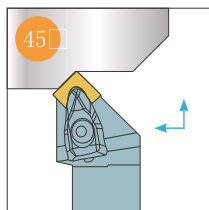

右手刀
right-hand tool

| 编号 Part number | 尺寸 Size | | | | | | 刀片 Inserts | 垫片 Shim | 销钉 Pin | 压板 Platen | 螺钉 Screw | 弹簧 Spring | 扳手 Wrench |
|-------------------|---------|----|----|-----|----|----|---------------|------------|-----------|--------------|-------------|--------------|--------------|
| | H | h | W | L | L1 | s | | | | | | | |
| DSSNR2020K12 | 20 | 20 | 20 | 125 | 34 | 25 | SN**1204** | MS43 | S5012T | D-CLM4 | D-LS4 | D-SP4 | HL3,TIP20 |
| DSSNR2525M12 | 25 | 25 | 25 | 150 | 34 | 32 | | | | | | | |

DTJN

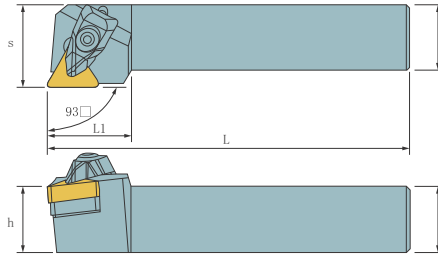
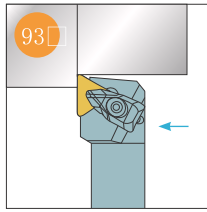

右手刀
right-hand tool

| 编号 Part number | 尺寸 Size | | | | | | 刀片 Inserts | 垫片 Shim | 销钉 Pin | 压板 Platen | 螺钉 Screw | 弹簧 Spring | 扳手 Wrench |
|-------------------|---------|----|----|-----|----|----|---------------|------------|-----------|--------------|-------------|--------------|--------------|
| | H | h | W | L | L1 | s | | | | | | | |
| DTJNR/L2020K16 | 20 | 20 | 20 | 125 | 30 | 25 | TN**1604** | MT32 | S4012T | D-CLM3 | D-LS3 | D-SP3 | HL2.5 |
| DTJNR/L2525M16 | 25 | 25 | 25 | 150 | 30 | 32 | | | | | | | |

DVJN

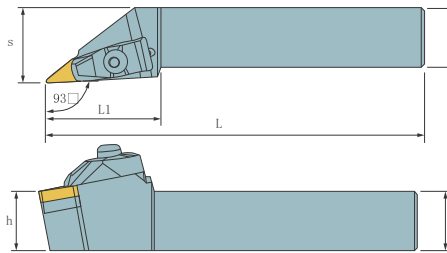
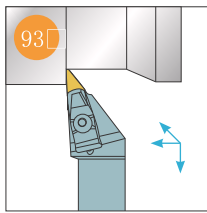

右手刀
right-hand tool

| 编号 Part number | 尺寸 Size | | | | | | 刀片 Inserts | 垫片 Shim | 销钉 Pin | 压板 Platen | 螺钉 Screw | 弹簧 Spring | 扳手 Wrench |
|-------------------|---------|----|----|-----|----|----|---------------|------------|-----------|--------------|-------------|--------------|--------------|
| | H | h | W | L | L1 | s | | | | | | | |
| DVJNR/L2020K16 | 20 | 20 | 20 | 125 | 30 | 25 | VN**1604** | MV32 | S4012T | D-CLV3 | D-LS5 | D-SP5 | HL2.5,HL4 |
| DVJNR/L2525M16 | 25 | 25 | 25 | 150 | 30 | 32 | | | | | | | |

DVVNN

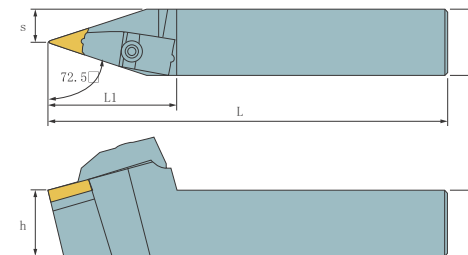
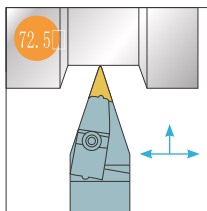

| 编号 Part number | 尺寸 Size | | | | | | 刀片 Inserts | 垫片 Shim | 销钉 Pin | 压板 Platen | 螺钉 Screw | 弹簧 Spring | 扳手 Wrench |
|-------------------|---------|----|----|-----|----|------|---------------|------------|-----------|--------------|-------------|--------------|--------------|
| | H | h | W | L | L1 | s | | | | | | | |
| DVVNN2020K16 | 20 | 20 | 20 | 125 | 49 | 10 | VN**1604** | MV32 | S4012T | D-CLV3 | D-LS5 | D-SP5 | HL2.5,HL4 |
| DVVNN2525M16 | 25 | 25 | 25 | 150 | 49 | 12.5 | | | | | | | |

DWLN

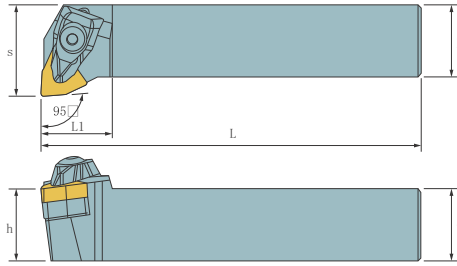
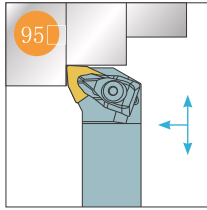

右手刀
right-hand tool

| 编号 Part number | 尺寸 Size | | | | | | 刀片 Inserts | 垫片 Shim | 销钉 Pin | 压板 Platen | 螺钉 Screw | 弹簧 Spring | 扳手 Wrench |
|-------------------|---------|----|----|-----|----|----|---------------|------------|-----------|--------------|-------------|--------------|--------------|
| | H | h | W | L | L1 | s | | | | | | | |
| DWLNRL2020K06 | 20 | 20 | 20 | 125 | 28 | 25 | WN**0604** | MW32 | S4012T | D-CLM3 | D-LS3 | D-SP3 | HL2.5 |
| DWLNRL2525M06 | 25 | 25 | 25 | 150 | 28 | 32 | | | | | | | |
| DWLNRL2020K08 | 20 | 20 | 20 | 125 | 31 | 25 | WN**0804** | MW43 | S5012T | D-CLM4 | D-LS4 | D-SP4 | HL3,TIP20 |
| DWLNRL2525M08 | 25 | 25 | 25 | 150 | 31 | 32 | | | | | | | |
| DWLNRL3232P08 | 32 | 32 | 32 | 170 | 31 | 40 | | | | | | | |

地址：河南省郑州市高新区长椿路国家大学科技园研发5B
 电话：400-119-3315 0371-86566583
 传真：0371-67981990
 网址：<http://www.hlcbn.org>

Address: Research 5# Building B site, the national university science park, Hi-tech District, Zhengzhou, Henan Province, China
 Tel: +86 371 86566583
 Fax: +86 371 67981990
 Web: www.halnn-group.com

K 華菱超硬
HALNN SUPERHARD
 郑州华菱超硬材料有限公司